

Features

- Package with screw terminals
- Isolation voltage 3000 V~
- Planar passivated chips
- Blocking voltage up to 1800 V
- Low forward voltage drop
- UL registered E332185



Applications

- Supplies for DC power equipment
- Input rectifiers for PWM inverter
- Battery DC power supplies
- Field supply for DC motors

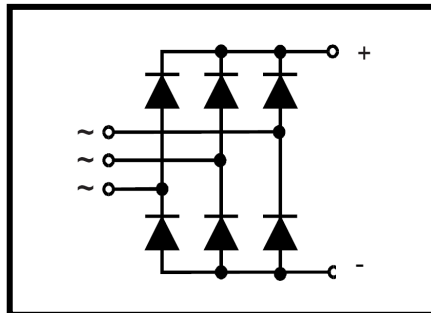

Advantages

- Easy to mount with two screws
- Space and weight savings
- Improved temperature and power cycling

ABSOLUTE MAXIMUM RATINGS

$T_C=25^{\circ}\text{C}$ unless otherwise specified

Symbol	Test Condition	Value	Unit
V_{RRM}		1800	V
$I_{d(AV)}$	$T_C=100^{\circ}\text{C}$, module	250	A
I_{FSM}	$T_J=45^{\circ}\text{C}$; $t=10\text{ms}$ (50Hz),sine	2500	A
	$V_R=0$ $t=8.3\text{ms}$ (60Hz),sine	2800	A
	$T_J=150^{\circ}\text{C}$; $t=10\text{ms}$ (50Hz),sine	2000	A
	$V_R=0$ $t=8.3\text{ms}$ (60Hz),sine	2250	A
I^2t	$T_J=45^{\circ}\text{C}$; $t=10\text{ms}$ (50Hz),sine	31250	A^2s
	$V_R=0$ $t=8.3\text{ms}$ (60Hz),sine	39200	A^2s
	$T_J=150^{\circ}\text{C}$; $t=10\text{ms}$ (50Hz),sine	20000	A^2s
	$V_R=0$ $t=8.3\text{ms}$ (60Hz),sine	25300	A^2s
T_J, T_{STG}		-40 to +150	$^{\circ}\text{C}$
T_{JM}		150	$^{\circ}\text{C}$
V_{ISOL}	50/60Hz RMS $t=1$ min	2500	V~
	$I_{ISOL}\leq 1\text{mA}$ $t=1$ s	3000	V~
Md	Mounting torque(M6)	$5\pm 15\%$	N·m
	Terminal connection torque(M6)	$5\pm 15\%$	N·m
Weight	typical	205	g

ELECTRICAL AND THERMAL CHARACTERISTICS $T_C=25^{\circ}\text{C}$ unless otherwise specified

Symbol	Test Condition	Value	Unit
I_R	$V_R = V_{RRM}; T_J = 25^{\circ}\text{C}$	≤ 0.5	mA
	$V_R = V_{RRM}; T_J = T_{JM}$	≤ 5	mA
V_F	$I_F = 300\text{A}; T_J = 125^{\circ}\text{C}$	1.43	V
V_{T0}	For power-loss calculations only	0.8	V
R_{thJC}	per diode	0.48	K/W
	Per module	0.08	K/W
R_{thCS}	per diode	0.18	K/W
	per module	0.03	K/W
d_S	Creeping distance on surface	10	mm
d_A	Cree page distance in air	9.4	mm
a	Max. allowable acceleration	50	m/s^2

NOTE: Data according to IEC 60747 and refer to a single diode unless otherwise stated.

Package Outline (Dimensions in mm)

