

## Features

- Package with screw terminals
- Isolation voltage 3000 V~
- Planar passivated chips
- Blocking voltage up to 1200 V
- Low forward voltage drop



## Applications

- Supplies for DC power equipment
- Input rectifiers for PWM inverter
- Battery DC power supplies
- Field supply for DC motors

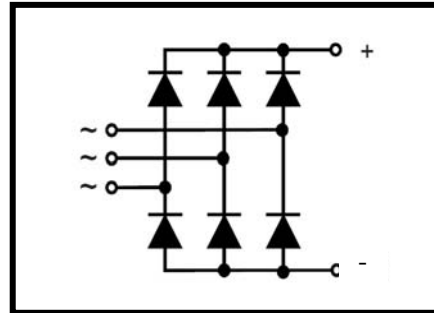

## Advantages

- Easy to mount with two screws
- Space and weight savings
- Improved temperature and power cycling

## ABSOLUTE MAXIMUM RATINGS

$T_C=25^{\circ}\text{C}$  unless otherwise specified

Symbol	Test Condition	Value	Unit
$V_{RRM}$		1800	V
$I_{d(AV)}$	$T_C=100^{\circ}\text{C}$ , module	200	A
$I_{FSM}$	$T_J=45^{\circ}\text{C}$ ; $t=10\text{ms}$ (50Hz),sine	2000	A
	$V_R=0$ $t=8.3\text{ms}$ (60Hz),sine	2200	A
	$T_J=150^{\circ}\text{C}$ ; $t=10\text{ms}$ (50Hz),sine	1800	A
	$V_R=0$ $t=8.3\text{ms}$ (60Hz),sine	1950	A
$I^2t$	$T_J=45^{\circ}\text{C}$ ; $t=10\text{ms}$ (50Hz),sine	20000	$\text{A}^2\text{s}$
	$V_R=0$ $t=8.3\text{ms}$ (60Hz),sine	24200	$\text{A}^2\text{s}$
	$T_J=150^{\circ}\text{C}$ ; $t=10\text{ms}$ (50Hz),sine	16200	$\text{A}^2\text{s}$
	$V_R=0$ $t=8.3\text{ms}$ (60Hz),sine	19010	$\text{A}^2\text{s}$
$T_J, T_{STG}$		-40 to +150	$^{\circ}\text{C}$
$T_{JM}$		150	$^{\circ}\text{C}$
$V_{ISOL}$	50/60Hz RMS $t=1$ min	2500	V~
	$I_{ISOL}\leq 1\text{mA}$ $t=1$ s	3000	V~
Md	Mounting torque(M6)	$5\pm 15\%$	N·m
	Terminal connection torque(M6)	$5\pm 15\%$	N·m
Weight	typical	205	g

MacMic Science & Technology Co., Ltd.

Add: #18, Hua Shan Zhong Lu, New District, Changzhou City, Jiangsu Province, P. R. of China

Tel.: +86-519-85163708 Fax: +86-519-85162291 Post Code: 213022 Website: [www.macmicst.com](http://www.macmicst.com)

**ELECTRICAL AND THERMAL CHARACTERISTICS**  $T_C=25^\circ\text{C}$  unless otherwise specified

Symbol	Test Condition	Value	Unit
$I_R$	$V_R = V_{RRM}; T_J = 25^\circ\text{C}$	$\leq 0.5$	mA
	$V_R = V_{RRM}; T_J = T_{JM}$	$\leq 5$	mA
$V_F$	$I_F = 300\text{A}; T_J = 125^\circ\text{C}$	1.51	V
$V_{T0}$	For power-loss calculations only	0.8	V
$R_{thJC}$	per diode	0.54	K/W
	Per module	0.09	K/W
$R_{thCS}$	per diode	0.18	K/W
	per module	0.03	K/W
$d_S$	Creeping distance on surface	10	mm
$d_A$	Cree page distance in air	9.4	mm
$a$	Max. allowable acceleration	50	$\text{m/s}^2$

**NOTE:** Data according to IEC 60747 and refer to a single diode unless otherwise stated.

**Package Outline (Dimensions in mm)**

