

FEATURES

- Ultra Low Loss
- High Ruggedness
- High Short Circuit Capability
- $V_{CE(sat)}$ With Positive Temperature Coefficient
- With Fast Free-Wheeling Diodes

APPLICATIONS

- AC and DC motor control
- AC servo and robot drives
- Power supplies
- Welding inverters

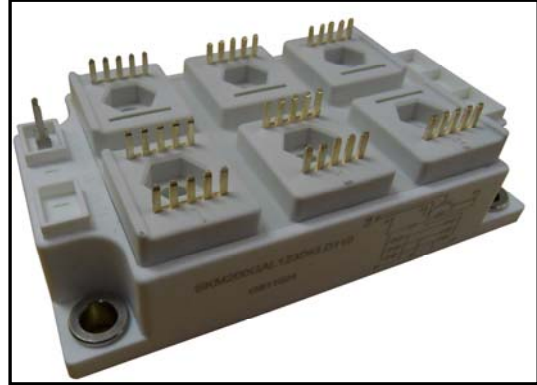

BRAKE-CHOPPER SECTOR

ABSOLUTE MAXIMUM RATINGS

$T_C=25^{\circ}\text{C}$ unless otherwise specified

Symbol	Parameter	Test Conditions	Values	Unit
IGBT-Inverter				
V_{CES}	Collector - Emitter Voltage	$T_{Vj}=25^{\circ}\text{C}$	1200	V
V_{GES}	Gate - Emitter Voltage		± 20	V
I_C	DC Collector Current	$T_C=25^{\circ}\text{C}$	300	A
		$T_C=80^{\circ}\text{C}$	200	A
I_{CM}	Repetitive Peak Collector Current	$t_p=1\text{ms}$	400	A
P_{tot}	Power Dissipation Per IGBT		1040	W
Diode-Serial				
V_{RRM}	Repetitive Reverse Voltage	$T_{Vj}=25^{\circ}\text{C}$	1200	V
$I_{F(AV)}$	Average Forward Current	$T_C=25^{\circ}\text{C}$	300	A
		$T_C=80^{\circ}\text{C}$	200	A
I_{FRM}	Repetitive Peak Forward Current	$t_p=1\text{ms}$	400	A
I^2t		$T_{Vj}=45^{\circ}\text{C}$, $t=10\text{ms}$, $V_R=0\text{V}$	15312	A^2s
Reverse-Diode				
V_{RRM}	Repetitive Reverse Voltage	$T_{Vj}=25^{\circ}\text{C}$	1200	V
$I_{F(AV)}$	Average Forward Current	$T_C=25^{\circ}\text{C}$	45	A
		$T_C=80^{\circ}\text{C}$	30	A
I_{FRM}	Repetitive Peak Forward Current	$t_p=1\text{ms}$	60	A
I^2t		$T_{Vj}=45^{\circ}\text{C}$, $t=10\text{ms}$, $V_R=0\text{V}$	450	A^2s

SKM200GAL123DKLD110

BRAKE-CHOPPER SECTOR

ELECTRICAL AND THERMAL CHARACTERISTICS

$T_C=25^{\circ}\text{C}$ unless otherwise specified

Symbol	Parameter	Test Conditions	Min.	Typ.	Max.	Unit
IGBT-Inverter						
$V_{GE(th)}$	Gate - Emitter Threshold Voltage	$V_{CE}=V_{GE}, I_C=8\text{mA}$	5.2	6	7	V
$V_{CE(sat)}$	Collector - Emitter Saturation Voltage	$I_C=200\text{A}, V_{GE}=15\text{V}, T_{Vj}=25^{\circ}\text{C}$		1.8		V
		$I_C=200\text{A}, V_{GE}=15\text{V}, T_{Vj}=125^{\circ}\text{C}$		2.0		V
I_{CES}	Collector Leakage Current	$V_{CE}=1200\text{V}, V_{GE}=0\text{V}, T_{Vj}=25^{\circ}\text{C}$			1	mA
		$V_{CE}=1200\text{V}, V_{GE}=0\text{V}, T_{Vj}=125^{\circ}\text{C}$			10	mA
I_{GES}	Gate Leakage Current	$V_{CE}=0\text{V}, V_{GE} \pm 15\text{V}, T_{Vj}=125^{\circ}\text{C}$	-400		400	nA
Q_{ge}	Gate Charge	$V_{CE}=600\text{V}, I_C=200\text{A}, V_{GE} = \pm 15\text{V}$		2.1		μC
C_{ies}	Input Capacitance	$V_{CE}=25\text{V}, V_{GE}=0\text{V}, f=1\text{MHz}$		14.9		nF
C_{res}	Reverse Transfer Capacitance			0.7		nF
$t_{d(on)}$	Turn - on Delay Time	$V_{CC}=600\text{V}, I_C=200\text{A}, T_{Vj}=25^{\circ}\text{C}$		130		ns
		$R_G=5.1\ \Omega, T_{Vj}=125^{\circ}\text{C}$		140		ns
t_r	Rise Time	$V_{GE} = \pm 15\text{V}, T_{Vj}=25^{\circ}\text{C}$		65		ns
		Inductive Load $T_{Vj}=125^{\circ}\text{C}$		65		ns
$t_{d(off)}$	Turn - off Delay Time	$V_{CC}=600\text{V}, I_C=200\text{A}, T_{Vj}=25^{\circ}\text{C}$		430		ns
		$R_G=5.1\ \Omega, T_{Vj}=125^{\circ}\text{C}$		500		ns
t_f	Fall Time	$V_{GE} = \pm 15\text{V}, T_{Vj}=25^{\circ}\text{C}$		65		ns
		Inductive Load $T_{Vj}=125^{\circ}\text{C}$		80		ns
E_{on}	Turn - on Energy	$V_{CC}=600\text{V}, I_C=200\text{A}, T_{Vj}=25^{\circ}\text{C}$		17.2		mJ
		$R_G=5.1\ \Omega, T_{Vj}=125^{\circ}\text{C}$		24.8		mJ
E_{off}	Turn - off Energy	$V_{GE} = \pm 15\text{V}, T_{Vj}=25^{\circ}\text{C}$		13.6		mJ
		Inductive Load $T_{Vj}=125^{\circ}\text{C}$		21.6		mJ
I_{sc}	Short Circuit Current	$t_{psc} \leq 10\ \mu\text{s}, V_{GE}=15\text{V}, T_{Vj}=125^{\circ}\text{C}$ $V_{CC}=900\text{V}, V_{CEMCHIP} \leq 1200\text{V}$		900		A
R_{thJC}	Junction-to-Case Thermal Resistance (Per IGBT)				0.12	K/W
Diode-Serial						
V_F	Forward Voltage	$I_F=200\text{A}, V_{GE}=0\text{V}, T_{Vj}=25^{\circ}\text{C}$		1.95		V
		$I_F=200\text{A}, V_{GE}=0\text{V}, T_{Vj}=125^{\circ}\text{C}$		1.95		V
I_{RRM}	Max. Reverse Recovery Current	$I_F=200\text{A}, V_R=600\text{V}$		155		A
Q_{rr}	Reverse Recovery Charge	$di_F/dt=-2400\text{A}/\mu\text{s}$		17.5		μC
E_{rec}	Reverse Recovery Energy	$T_{Vj}=125^{\circ}\text{C}$		8.5		mJ
R_{thJCD}	Junction-to-Case Thermal Resistance (Per Diode)				0.25	K/W
Reverse-Diode						
V_F	Forward Voltage	$I_F=30\text{A}, V_{GE}=0\text{V}, T_{Vj}=25^{\circ}\text{C}$		1.53		V
I_{RRM}	Max. Reverse Recovery Current	$I_F=30\text{A}, V_R=600\text{V}$		60		A
Q_{rr}	Reverse Recovery Charge	$di_F/dt=-1000\text{A}/\mu\text{s}, T_{Vj}=125^{\circ}\text{C}$		5.5		μC
R_{thJCD}	Junction-to-Case Thermal Resistance (Per Diode)				1.0	K/W

SKM200GAL123DKLD110

DIODE-RECTIFIER SECTOR

ABSOLUTE MAXIMUM RATINGS

$T_C=25^{\circ}\text{C}$ unless otherwise specified

Symbol	Parameter	Test Conditions	Values	Unit
V_{RRM}	Repetitive Reverse Voltage	$T_{Vj}=25^{\circ}\text{C}$	1600	V
$I_{D(AV)}$	Average Forward Current, Module	$T_C=80^{\circ}\text{C}$	200	A
I_{FSM}	Non-Repetitive Surge Forward Current	$T_{Vj}=45^{\circ}\text{C}$, $t=10\text{ms}$, 50Hz	2000	A
		$T_{Vj}=45^{\circ}\text{C}$, $t=8.3\text{ms}$, 60Hz	2200	A
I^2t		$T_{Vj}=45^{\circ}\text{C}$, $t=10\text{ms}$, 50Hz	20000	A^2s
		$T_{Vj}=45^{\circ}\text{C}$, $t=8.3\text{ms}$, 60Hz	24200	A^2s

DIODE-RECTIFIER SECTOR

ELECTRICAL AND THERMAL CHARACTERISTICS

$T_C=25^{\circ}\text{C}$ unless otherwise specified

Symbol	Parameter	Test Conditions	Min.	Typ.	Max.	Unit
V_F	Forward Voltage	$I_F=300\text{A}$, $T_{Vj}=25^{\circ}\text{C}$			1.51	V
I_R	Reverse Leakage Current	$V_R=1600\text{V}$, $T_{Vj}=25^{\circ}\text{C}$			50	μA
		$V_R=1600\text{V}$, $T_{Vj}=125^{\circ}\text{C}$			1	mA
R_{thJCD}	Junction-to-Case Thermal Resistance (Per Diode)				0.54	K / W

MODULE CHARACTERISTICS

$T_C=25^{\circ}\text{C}$ unless otherwise specified

Symbol	Parameter	Test Conditions	Min.	Typ.	Max.	Unit
$T_{Vj\max}$	Max. Junction Temperature				150	$^{\circ}\text{C}$
$T_{Vj\text{op}}$	Operating Temperature		-40		125	$^{\circ}\text{C}$
T_{stg}	Storage Temperature		-40		125	$^{\circ}\text{C}$
V_{isol}	Insulation Test Voltage	AC, $t=1\text{min}$		3000		V
M_d	Mounting Torque	Recommended (M6)	3		5	N · m
Weight				300		g

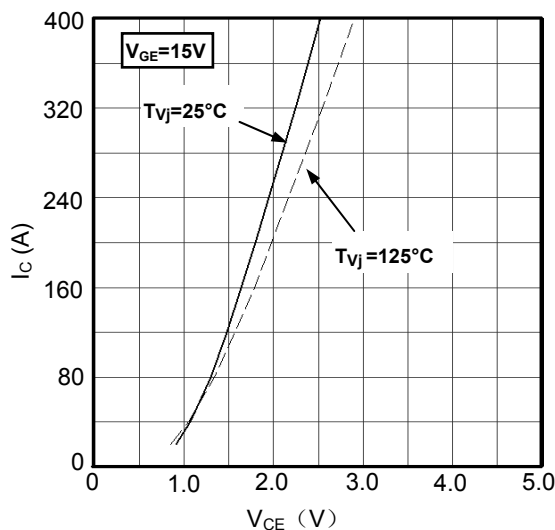

Figure1. Typical Output characteristics
IGBT-Inverter

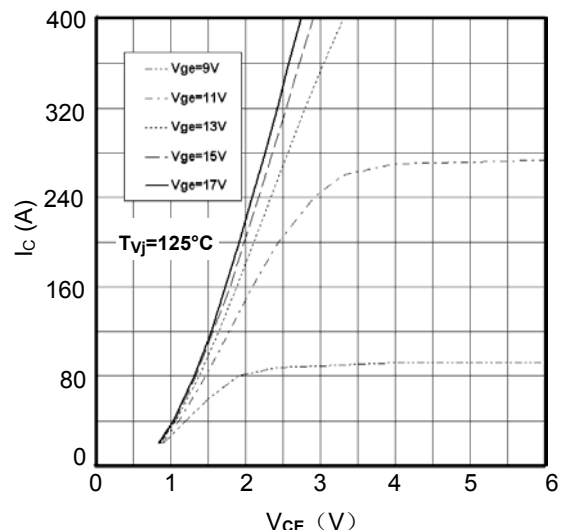

Figure2. Typical Output characteristics
IGBT-Inverter

SKM200GAL123DKLD110

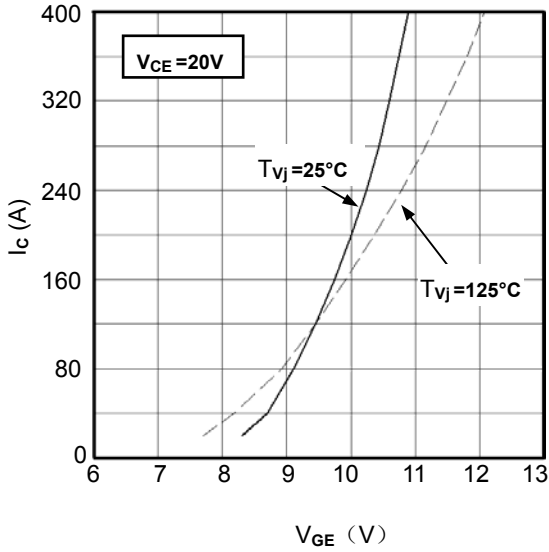

Figure3. Typical Transfer characteristics IGBT-Inverter

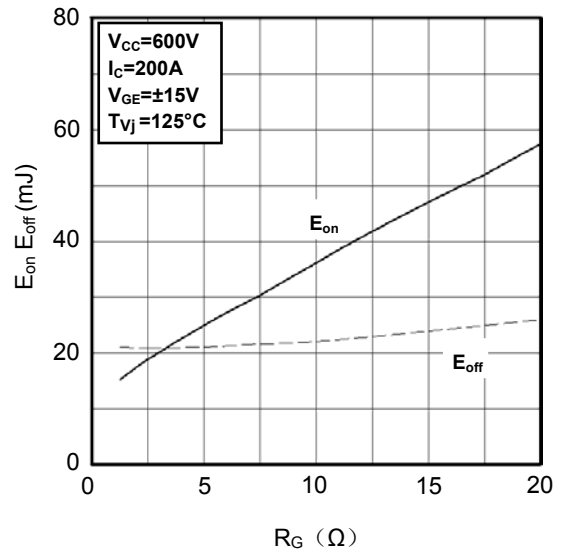

Figure4. Switching Energy vs. Gate Resistor IGBT-Inverter

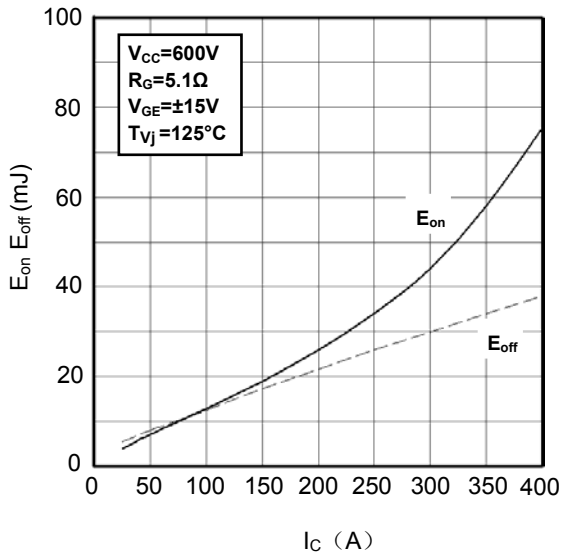

Figure5. Switching Energy vs. Collector Current IGBT-Inverter

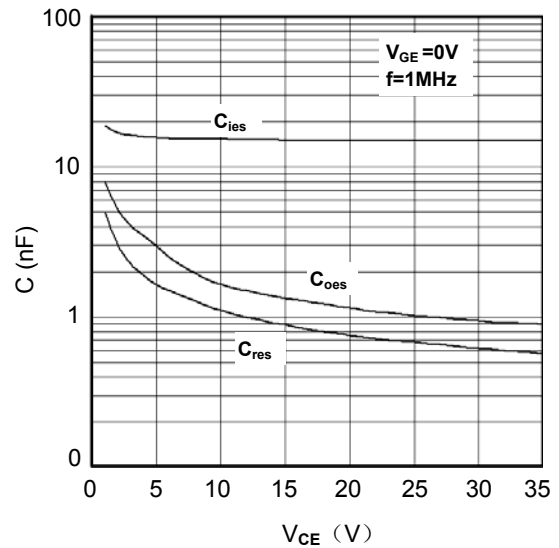

Figure6. Typical Capacitances vs. V_{CE} IGBT-Inverter

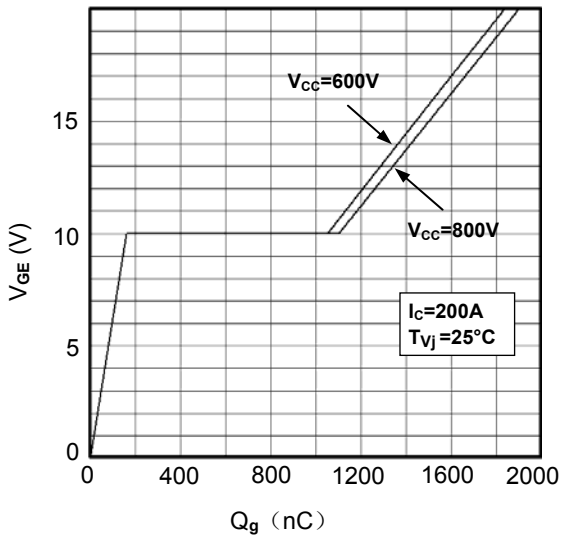

Figure7. Gate Charge characteristics IGBT-Inverter

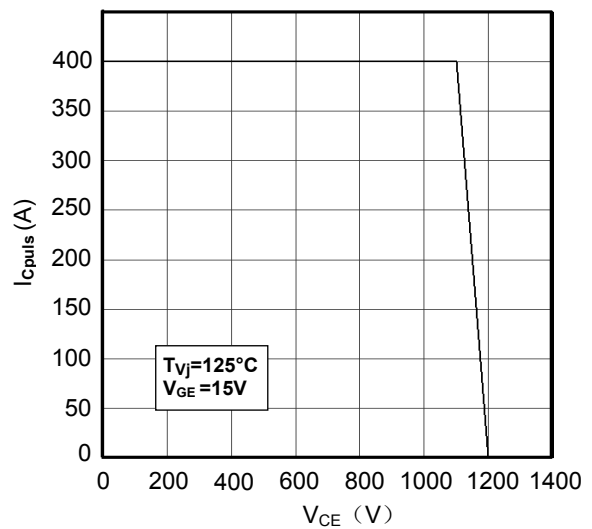

Figure8. Reverse Biased Safe Operating Area IGBT-Inverter

SKM200GAL123DKLD110

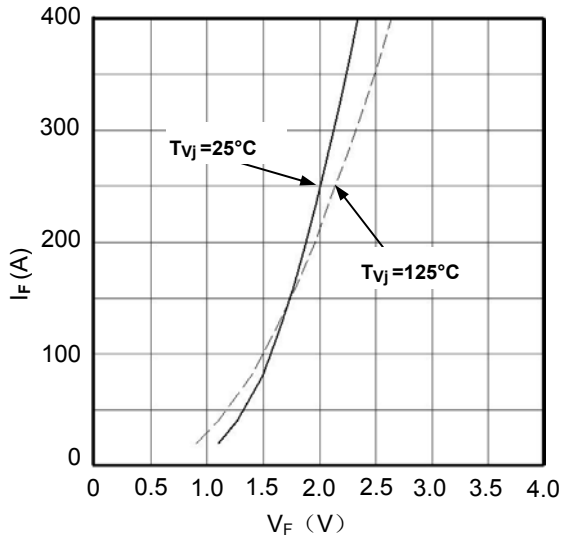

Figure9. Diode Forward Characteristics
Diode-Serial

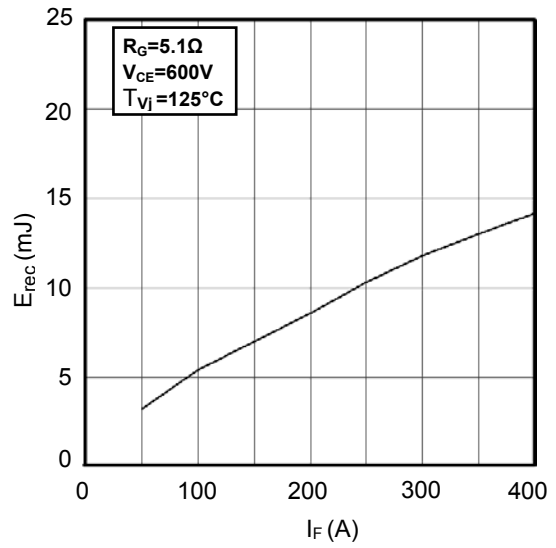

Figure10. Switching Energy vs. I_F
Diode-Serial

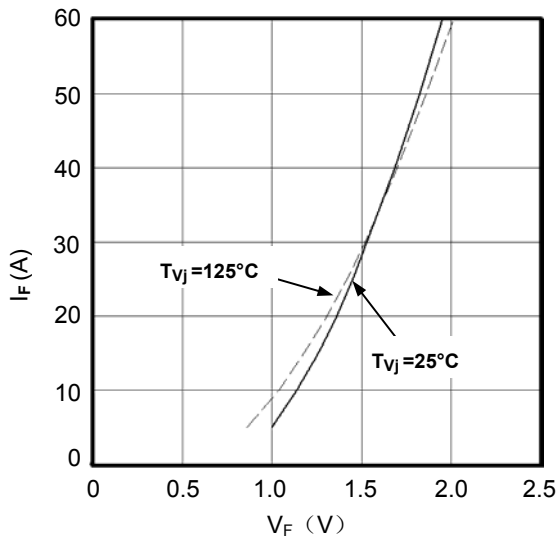

Figure11. Diode Forward Characteristics
Reverse-Diode

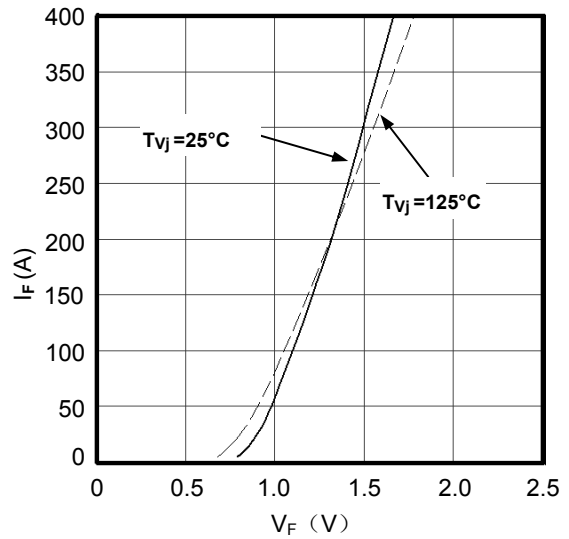
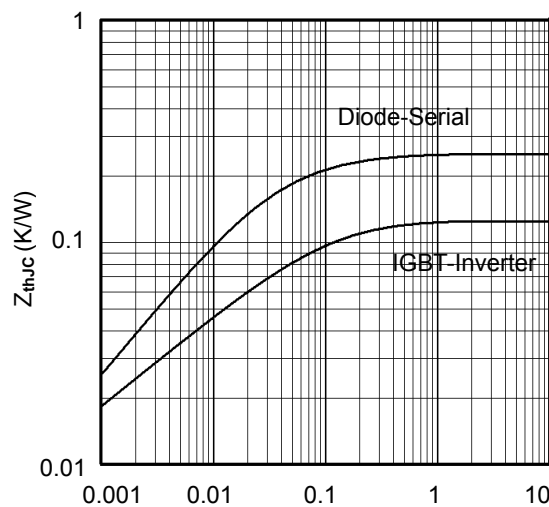

Figure12. Diode Forward Characteristics
Rectifier -Diode



Rectangular Pulse Duration (seconds)
Figure13. Transient Thermal Impedance

SKM200GAL123DKLD110

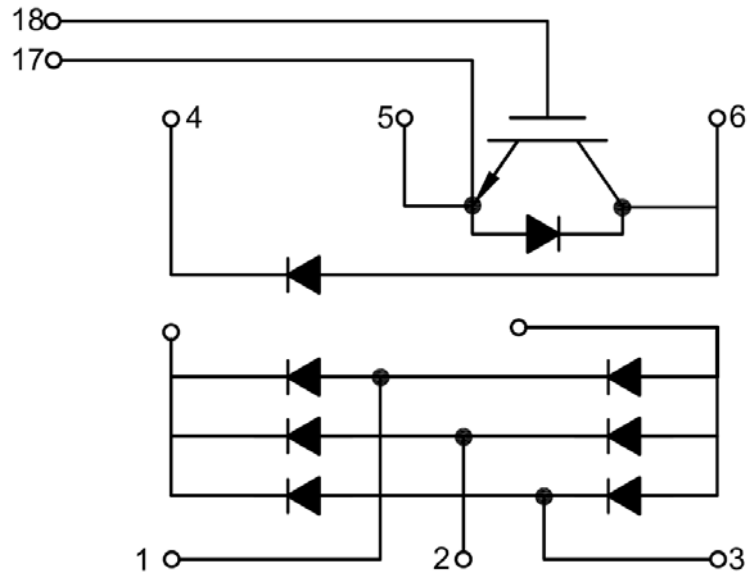
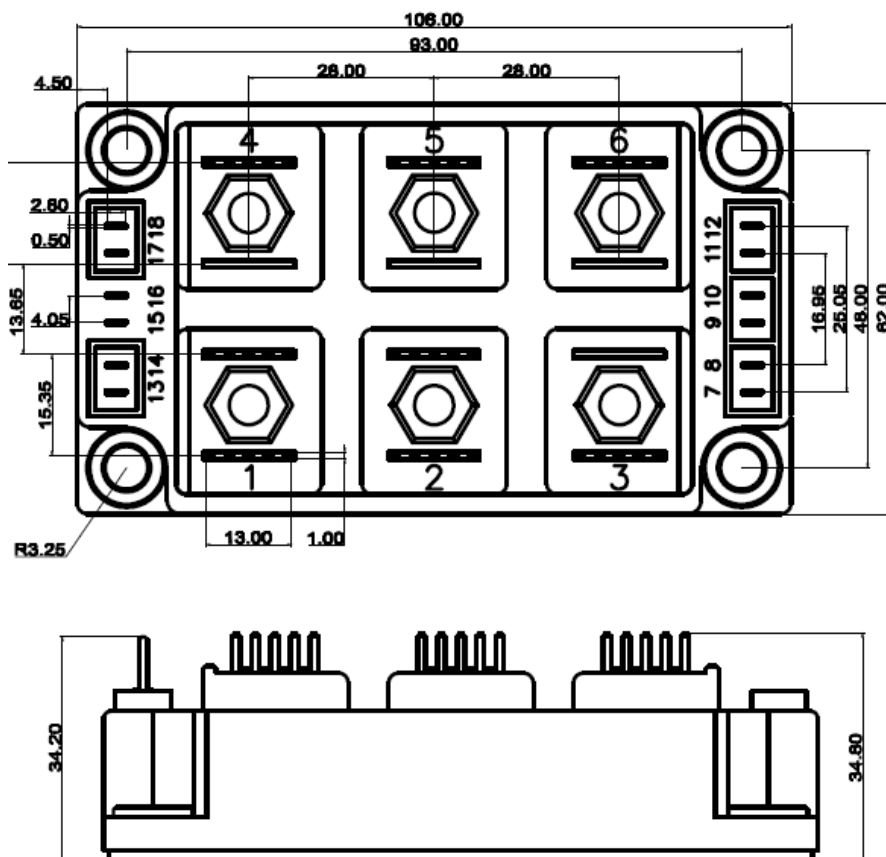

Figure14. Circuit Diagram



Dimensions (mm)
Figure15. Package Outline

SKM200GAL123DKLD110