

FEATURES

- Ultra Low Loss
- High Ruggedness
- High Short Circuit Capability
- Positive Temperature Coefficient
- With Fast Free-Wheeling Diodes

APPLICATIONS

- Invector
- Converter
- Welder
- SMPS and UPS
- Induction Heating



ABSOLUTE MAXIMUM RATINGS

$T_C=25^{\circ}\text{C}$ unless otherwise specified

Symbol	Parameter	Test Conditions	Values	Unit
IGBT				
V_{CES}	Collector - Emitter Voltage		1200	V
V_{GES}	Gate - Emitter Voltage		± 20	V
I_C	DC Collector Current	$T_C=25^{\circ}\text{C}$	150	A
		$T_C=80^{\circ}\text{C}$	105	A
I_{Cpuls}	Pulsed Collector Current	$T_C=25^{\circ}\text{C}, t_p=1\text{ms}$	300	A
		$T_C=80^{\circ}\text{C}, t_p=1\text{ms}$	210	A
P_{tot}	Power Dissipation Per IGBT		690	W
T_J	Junction Temperature Range		-40 to +150	$^{\circ}\text{C}$
T_{STG}	Storage Temperature Range		-40 to +125	$^{\circ}\text{C}$
V_{isol}	Insulation Test Voltage	AC, $t=1\text{min}$	3000	V
Free-Wheeling Diode				
V_{RRM}	Repetitive Reverse Voltage		1200	V
$I_{F(AV)}$	Average Forward Current	$T_C=25^{\circ}\text{C}$	125	A
		$T_C=80^{\circ}\text{C}$	85	A
$I_{F(RMS)}$	RMS Forward Current		122	A
I_{FSM}	Non-Repetitive Surge Forward Current	$T_J=45^{\circ}\text{C}, t=10\text{ms}, \text{Sine}$	930	A
		$T_J=45^{\circ}\text{C}, t=8.3\text{ms}, \text{Sine}$	980	A

MMG100SR120UZK

ELECTRICAL CHARACTERISTICS

T_C=25°C unless otherwise specified

Symbol	Parameter	Test Conditions	Min.	Typ.	Max.	Unit
IGBT						
V _{GE(th)}	Gate - Emitter Threshold Voltage	V _{CE} =V _{GE} , I _C =4mA	5	6.2	7	V
V _{CE(sat)}	Collector - Emitter Saturation Voltage	I _C =100A, V _{GE} =15V, T _J =25°C		1.8		V
		I _C =100A, V _{GE} =15V, T _J =125°C		2.0		V
I _{CES}	Collector Leakage Current	V _{CE} =1200V, V _{GE} =0V, T _J =25°C		0.2	0.5	mA
		V _{CE} =1200V, V _{GE} =0V, T _J =125°C		3		mA
I _{GES}	Gate Leakage Current	V _{CE} =0V, V _{GE} =±20V	-200		200	nA
Q _{ge}	Gate Charge	V _{CC} =600V, I _C =100A, V _{GE} =±15V		1050		nC
C _{ies}	Input Capacitance	V _{CE} =25V, V _{GE} =0V, f=1MHz		7.43		nF
C _{oes}	Output Capacitance			0.52		nF
C _{res}	Reverse Transfer Capacitance			0.34		nF
t _{d(on)}	Turn - on Delay Time	V _{CC} =600V, I _C =100A		125		ns
t _r	Rise Time	R _G = 10 Ω, V _{GE} =±15V		60		ns
t _{d(off)}	Turn - off Delay Time	T _J =25°C		420		ns
t _f	Fall Time	Inductive Load		60		ns
t _{d(on)}	Turn - on Delay Time	V _{CC} =600V, I _C =100A		135		ns
t _r	Rise Time	R _G = 10 Ω, V _{GE} =±15V		60		ns
t _{d(off)}	Turn - off Delay Time	T _J =125°C		490		ns
t _f	Fall Time	Inductive Load		75		ns
E _{on}	Turn - on Switching Energy	V _{CC} =600V, I _C =100A, T _J =25°C		8.6		mJ
		R _G = 10 Ω, T _J =125°C		12.4		mJ
E _{off}	Turn - off Switching Energy	V _{GE} =±15V, T _J =25°C		6.8		mJ
		Inductive Load, T _J =125°C		10.8		mJ
Free-Wheeling Diode						
V _F	Forward Voltage	I _F =100A, V _{GE} =0V, T _J =25°C		2.0	2.44	V
		I _F =100A, V _{GE} =0V, T _J =125°C		1.7	2.20	V
t _{rr}	Reverse Recovery Time	I _F =100A, V _R =800V		220		ns
I _{RRM}	Max. Reverse Recovery Current	di _F /dt=-1000A/μs		85		A
Q _{rr}	Reverse Recovery Charge	T _J =125°C		9.8		μC

THERMAL AND MECHANICAL CHARACTERISTICS

Symbol	Parameter	Test Conditions	Min.	Typ.	Max.	Unit
R _{thJC}	Junction-to-Case Thermal Resistance	Per IGBT			0.18	K /W
R _{thJCD}	Junction-to-Case Thermal Resistance	Per Inverse Diode			0.45	K /W
Torque	Module-to-Sink	Recommended (M6)	3		5	N · m
Torque	Module Electrodes	Recommended (M5)	2.5		5	N · m
Weight				150		g

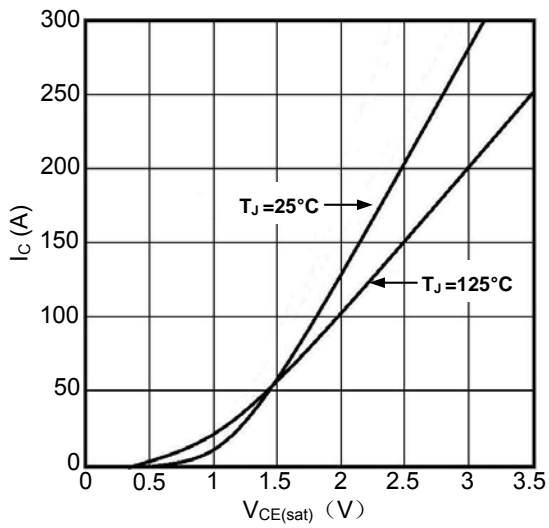

Figure1. Typical Output characteristics

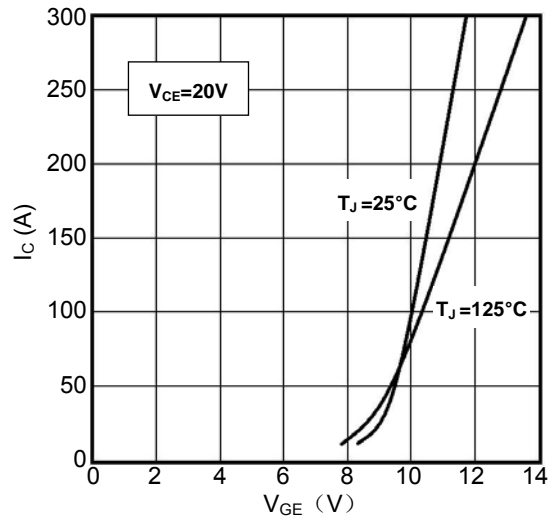

Figure2. Typical Transfer characteristics

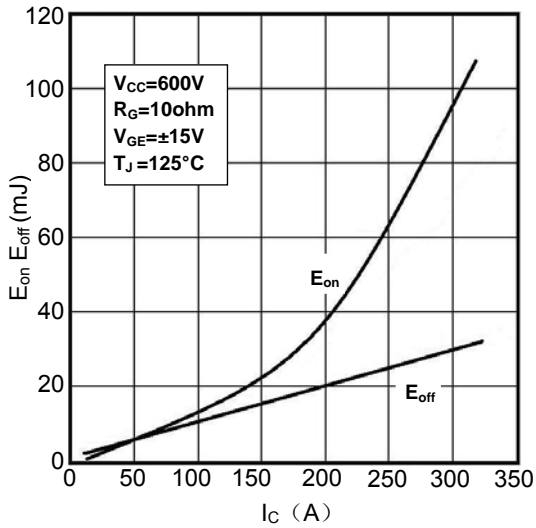

Figure3. Switching Energy vs. Collector Current

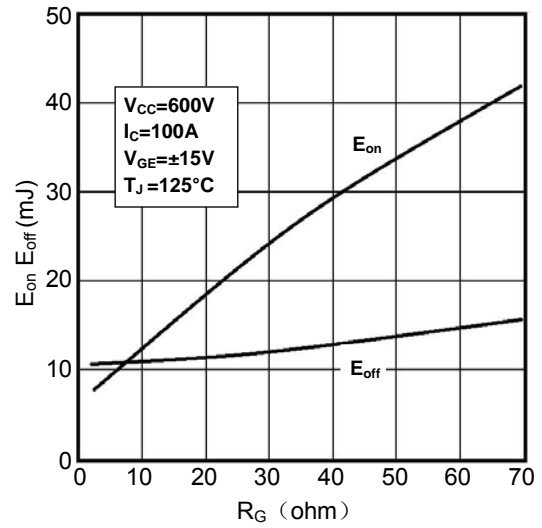

Figure4. Switching Energy vs. Gate Resistor

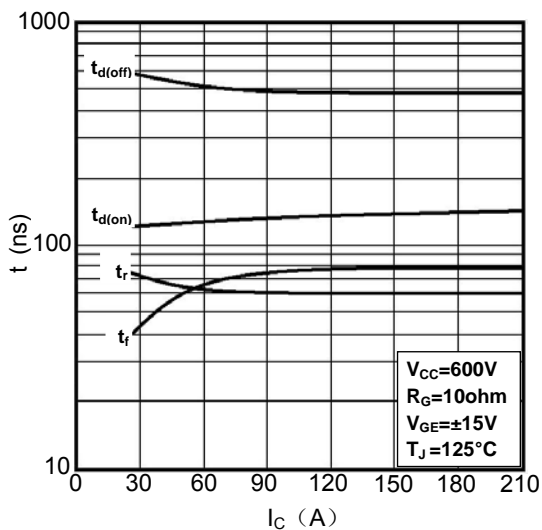

Figure5. Switching Times vs. Collector Current

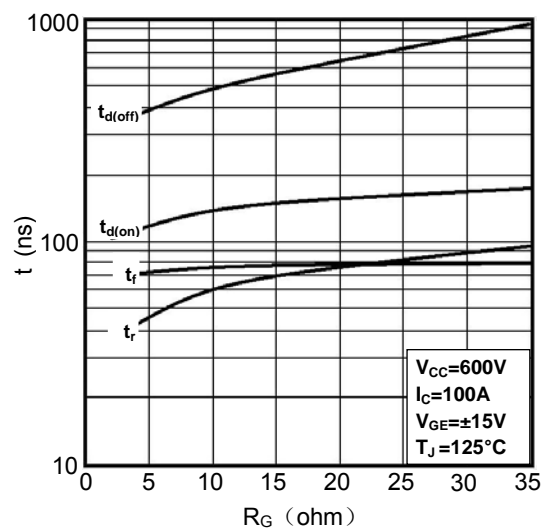

Figure6. Switching Times vs. Gate Resistor

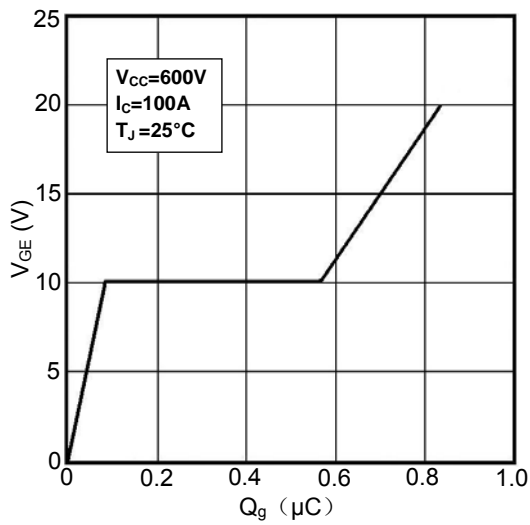

Figure7. Gate Charge characteristics

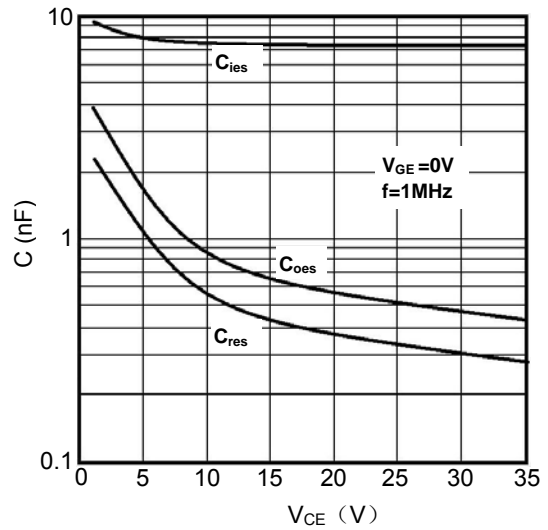

Figure8. Typical Capacitances vs. V_{CE}

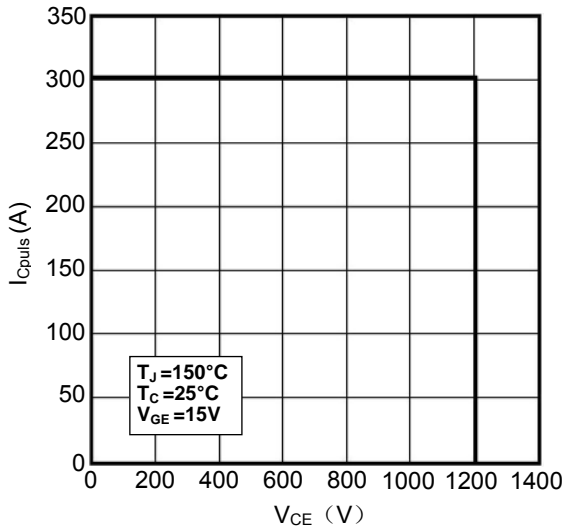

Figure9. Reverse Biased Safe Operating Area

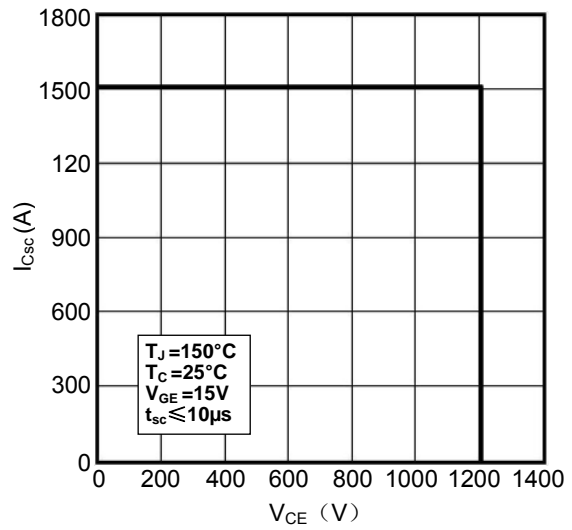

Figure10. Short Circuit Safe Operating Area

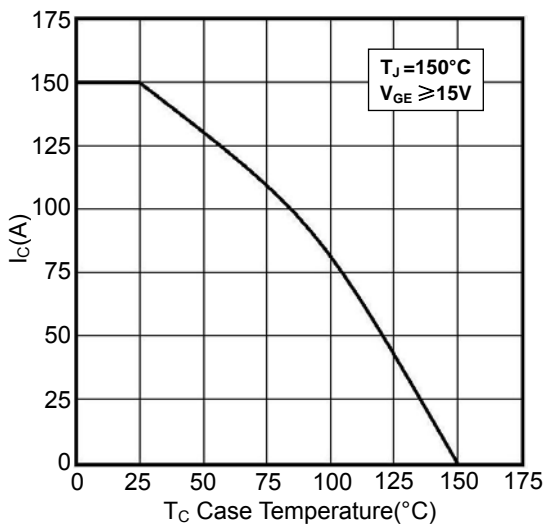

Figure11. Rated Current vs. T_C

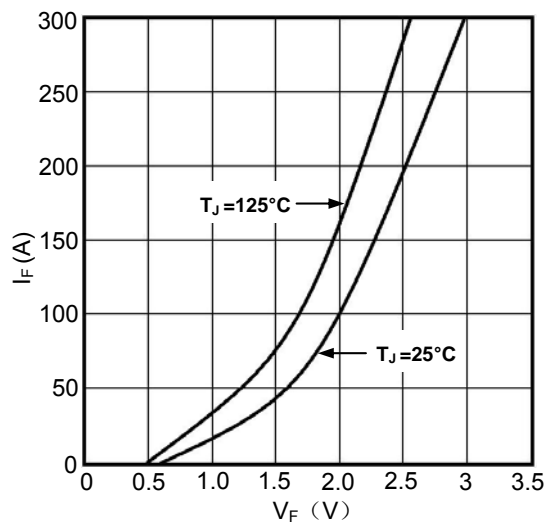
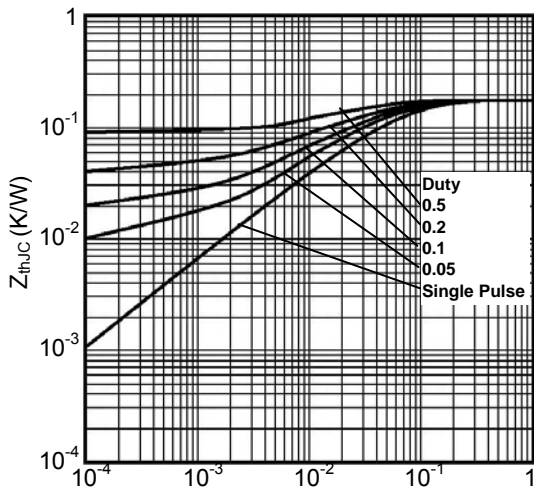
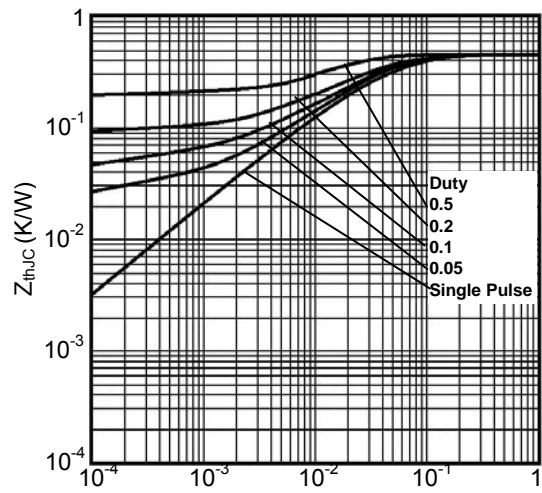

Figure12. Diode Forward Characteristics



Rectangular Pulse Duration (seconds)
Figure13. Transient Thermal Impedance of IGBT



Rectangular Pulse Duration (seconds)
Figure14. Transient Thermal Impedance of Diode

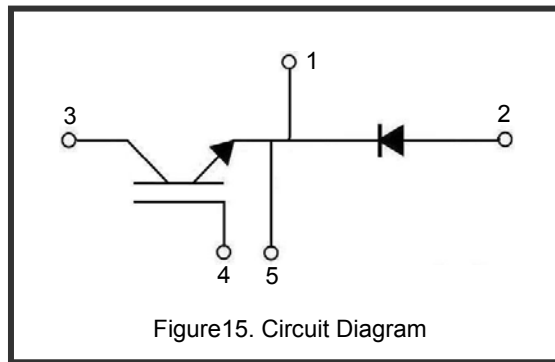

Figure15. Circuit Diagram

