

FEATURES

- High short circuit capability, self limiting short circuit current
- IGBT CHIP(T4 Fast Trench+Field Stop technology)
- $V_{CE(sat)}$ with positive temperature coefficient
- Fast switching and short tail current
- Free wheeling diodes with fast and soft reverse recovery
- Low switching losses
- $T_{Vj\ max} = 175^{\circ}C$

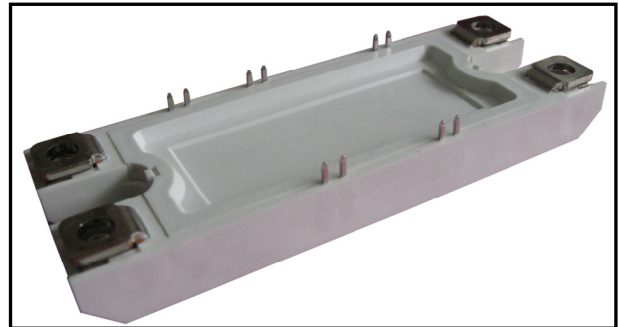

APPLICATIONS

- High frequency switching application
- Medical applications
- Motion/servo control
- UPS systems

INVERTER SECTOR

ABSOLUTE MAXIMUM RATINGS

$T_C=25^{\circ}C$ unless otherwise specified

Symbol	Parameter	Test Conditions	Values	Unit
IGBT				
V_{CES}	Collector - Emitter Voltage	$T_{Vj}=25^{\circ}C$	1200	V
V_{GES}	Gate - Emitter Voltage		± 20	V
I_C	DC Collector Current	$T_C=25^{\circ}C$	75	A
		$T_C=80^{\circ}C$	50	A
I_{CM}	Repetitive Peak Collector Current	$t_p=1ms$	100	A
P_{tot}	Power Dissipation Per IGBT		300	W
Diode				
V_{RRM}	Repetitive Reverse Voltage	$T_{Vj}=25^{\circ}C$	1200	V
$I_{F(AV)}$	Average Forward Current	$T_C=25^{\circ}C$	75	A
		$T_C=80^{\circ}C$	50	A
I_{FRM}	Repetitive Peak Forward Current	$t_p=1ms$	100	A
I^2t		$T_{Vj} = 125^{\circ}C, t=10ms, V_R=0V$	680	A^2s

MMG50HB120H6HN

INVERTER SECTOR

ELECTRICAL AND THERMAL CHARACTERISTICS

$T_C=25^{\circ}\text{C}$ unless otherwise specified

Symbol	Parameter	Test Conditions	Min.	Typ.	Max.	Unit
IGBT						
$V_{GE(th)}$	Gate - Emitter Threshold Voltage	$V_{CE}=V_{GE}, I_C=2.0\text{mA}$	5.4	6	6.5	V
$V_{CE(sat)}$	Collector - Emitter Saturation Voltage	$I_C=50\text{A}, V_{GE}=15\text{V}, T_{VJ}=25^{\circ}\text{C}$		2.1	2.5	V
		$I_C=50\text{A}, V_{GE}=15\text{V}, T_{VJ}=125^{\circ}\text{C}$		2.5		V
I_{CES}	Collector Leakage Current	$V_{CE}=1200\text{V}, V_{GE}=0\text{V}, T_{VJ}=25^{\circ}\text{C}$			2	mA
		$V_{CE}=1200\text{V}, V_{GE}=0\text{V}, T_{VJ}=125^{\circ}\text{C}$			10	mA
I_{GES}	Gate Leakage Current	$V_{CE}=0\text{V}, V_{GE} \pm 15\text{V}, T_{VJ}=125^{\circ}\text{C}$	-400		400	nA
R_{Gint}	Integrated Gate Resistor			4		Ω
Q_g	Gate Charge	$V_{CE}=600\text{V}, I_C=50\text{A}, V_{GE}=15\text{V}$		0.23		μC
C_{ies}	Input Capacitance	$V_{CE}=25\text{V}, V_{GE}=0\text{V}, f=1\text{MHz}$		2.8		nF
C_{res}	Reverse Transfer Capacitance			0.16		nF
$t_{d(on)}$	Turn - on Delay Time	$V_{CC}=600\text{V}, I_C=50\text{A},$ $R_G = 15 \Omega,$ $V_{GE} = \pm 15\text{V},$ Inductive Load	$T_{VJ} = 25^{\circ}\text{C}$	60		ns
			$T_{VJ} = 125^{\circ}\text{C}$	70		ns
			$T_{VJ} = 150^{\circ}\text{C}$	80		ns
t_r	Rise Time	Inductive Load	$T_{VJ} = 25^{\circ}\text{C}$	40		ns
			$T_{VJ} = 125^{\circ}\text{C}$	50		ns
			$T_{VJ} = 150^{\circ}\text{C}$	55		ns
$t_{d(off)}$	Turn - off Delay Time	$V_{CC}=600\text{V}, I_C=50\text{A},$ $R_G = 15 \Omega,$ $V_{GE} = \pm 15\text{V},$ Inductive Load	$T_{VJ} = 25^{\circ}\text{C}$	350		ns
			$T_{VJ} = 125^{\circ}\text{C}$	400		ns
			$T_{VJ} = 150^{\circ}\text{C}$	420		ns
t_f	Fall Time	Inductive Load	$T_{VJ} = 25^{\circ}\text{C}$	40		ns
			$T_{VJ} = 125^{\circ}\text{C}$	60		ns
			$T_{VJ} = 150^{\circ}\text{C}$	70		ns
E_{on}	Turn - on Energy	$V_{CC}=600\text{V}, I_C=50\text{A},$ $R_G = 15 \Omega,$ $V_{GE} = \pm 15\text{V},$ Inductive Load	$T_{VJ} = 125^{\circ}\text{C}$	5		mJ
			$T_{VJ} = 150^{\circ}\text{C}$	5.5		mJ
E_{off}	Turn - off Energy			3		mJ
I_{sc}	Short Circuit Current	$t_{psc} \leq 10\mu\text{S}, V_{GE}=15\text{V}$		200		A
		$T_{VJ}=125^{\circ}\text{C}, V_{CC}=600\text{V}$				
R_{thJC}	Junction-to-Case Thermal Resistance (Per IGBT)				0.50	K /W
Diode						
V_F	Forward Voltage	$I_F=50\text{A}, V_{GE}=0\text{V}, T_{VJ} = 25^{\circ}\text{C}$		1.65	2.15	V
		$I_F=50\text{A}, V_{GE}=0\text{V}, T_{VJ} = 125^{\circ}\text{C}$		1.65		V
t_{rr}	Reverse Recovery Time	$I_F=50\text{A}, V_R=600\text{V}$		275		ns
I_{RRM}	Max. Reverse Recovery Current	$di_F/dt=-1200\text{A}/\mu\text{s}$		50		A
E_{rec}	Reverse Recovery Energy	$T_{VJ} = 125^{\circ}\text{C}$		4.4		mJ
R_{thJCD}	Junction-to-Case Thermal Resistance (Per Diode)				0.75	K /W

MMG50HB120H6HN

NTC SECTOR

CHARACTERISTIC VALUES

$T_c=25^{\circ}\text{C}$ unless otherwise specified

Symbol	Parameter	Test Conditions	Min.	Typ.	Max.	Unit
R ₂₅	Resistance	T _c = 25°C		5		KΩ
B _{25/50}				3375		K

MODULE CHARACTERISTICS

$T_c=25^{\circ}\text{C}$ unless otherwise specified

Symbol	Parameter	Test Conditions	Min.	Typ.	Max.	Unit
T _{vj max}	Max. Junction Temperature				175	°C
T _{vj op}	Operating Temperature		-40		150	°C
T _{stg}	Storage Temperature		-40		125	°C
V _{isol}	Insulation Test Voltage	AC, t=1min		3000		V
CTI	Comparative Tracking Index		250			
Torque	Module-to-Sink	Recommended (M6)	3		5	N · m
Torque	Module Electrodes	Recommended (M5)	2.5		5	N · m
Weight				200		g

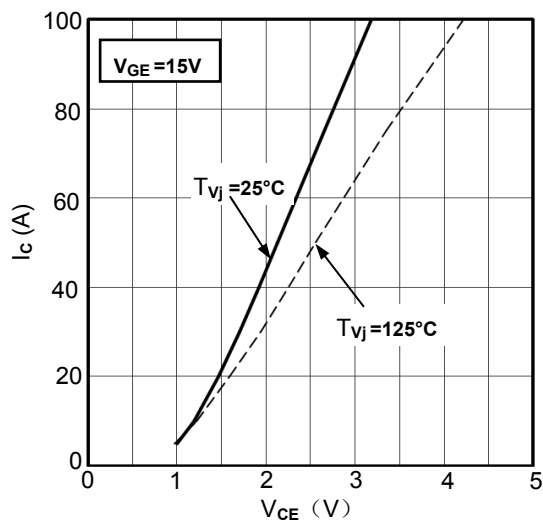

Figure1. Typical Output Characteristics IGBT-inverter

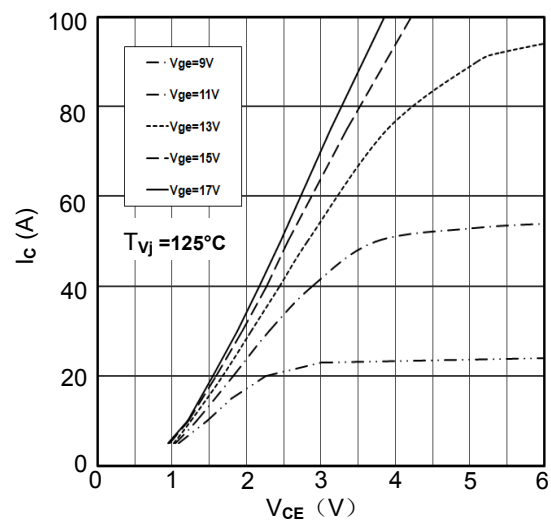

Figure2. Typical Output Characteristics IGBT-inverter

MMG50HB120H6HN

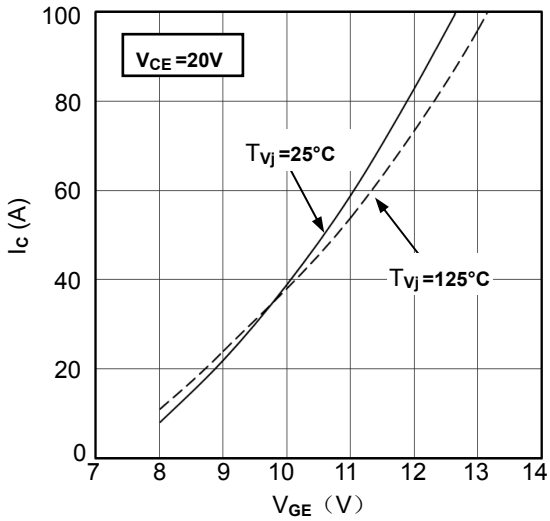

Figure3. Typical Transfer characteristics IGBT-inverter

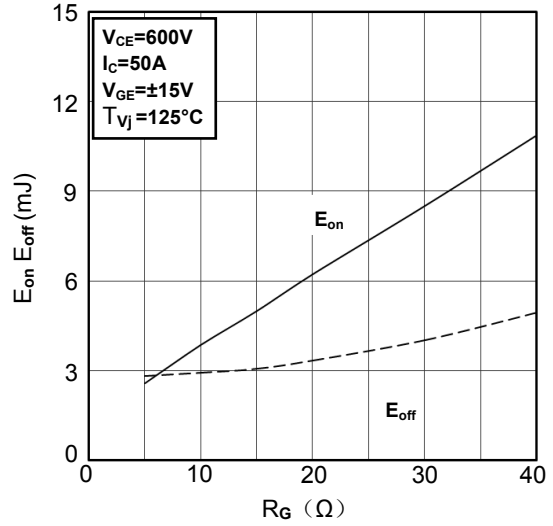

Figure4. Switching Energy vs. Gate Resistor IGBT-inverter

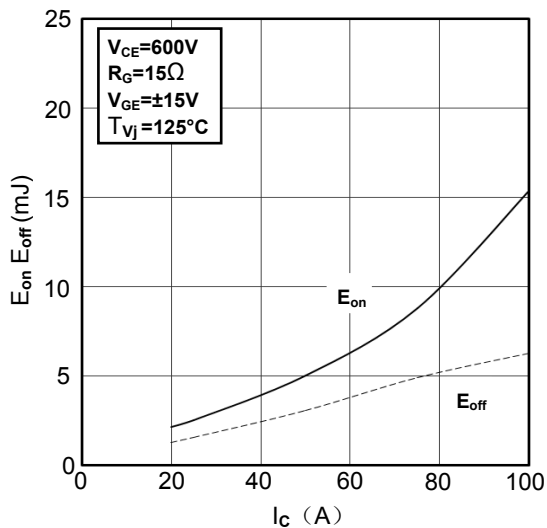

Figure5. Switching Energy vs. Collector Current IGBT-inverter

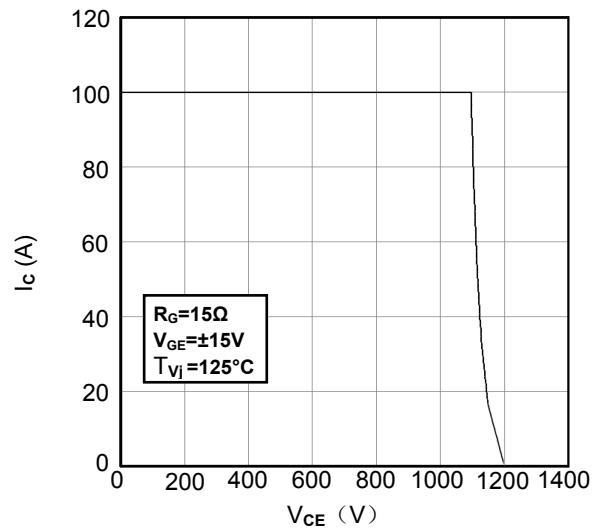

Figure6. Reverse Biased Safe Operating Area IGBT-inverter

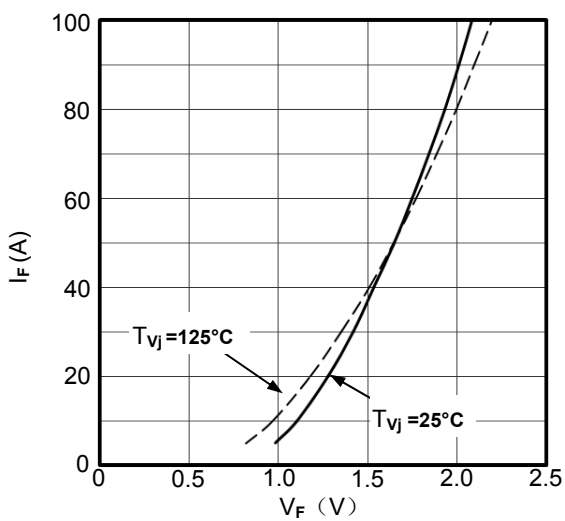

Figure7. Diode Forward Characteristics Diode-inverter

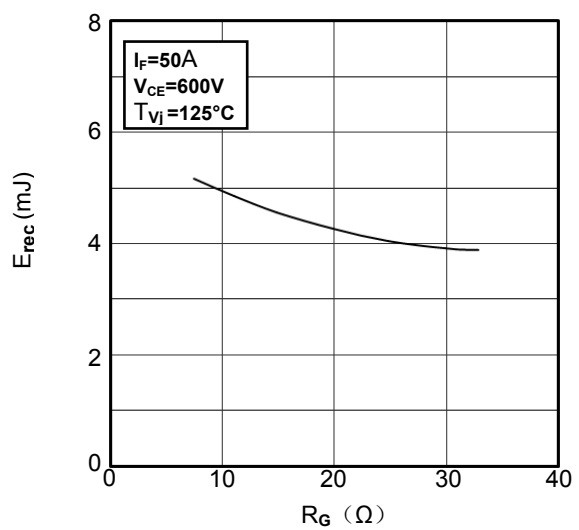

Figure8. Switching Energy vs. Gate Resistor Diode-inverter

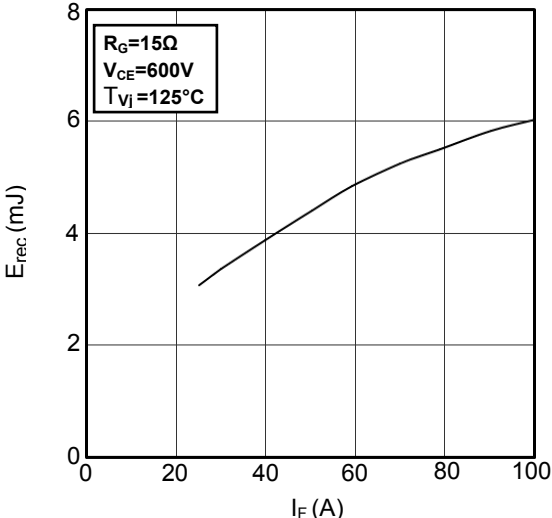

Figure9. Switching Energy vs. Forward Current Diode-inverter

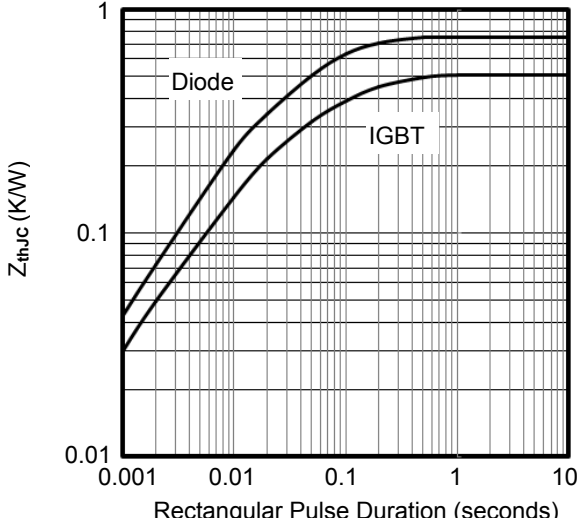

Figure10. Transient Thermal Impedance of Diode and IGBT-inverter

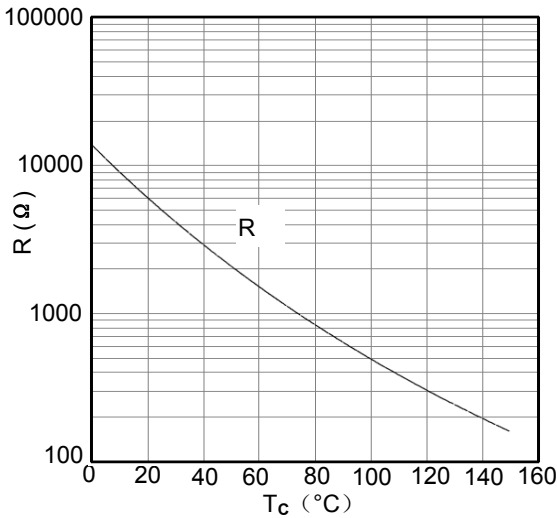

Figure11. NTC Characteristics

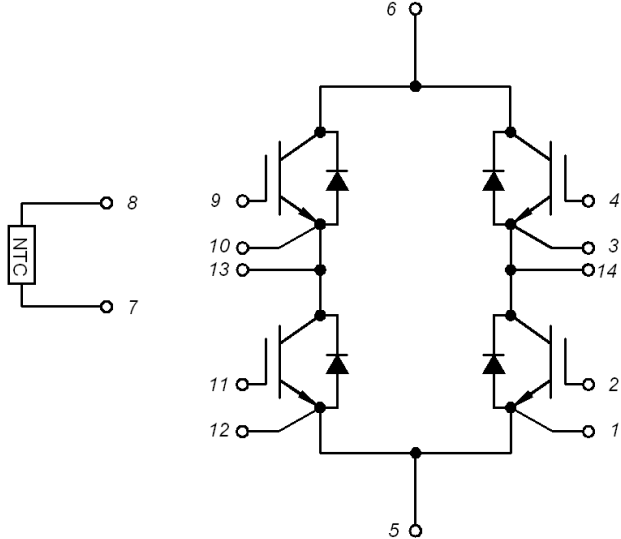
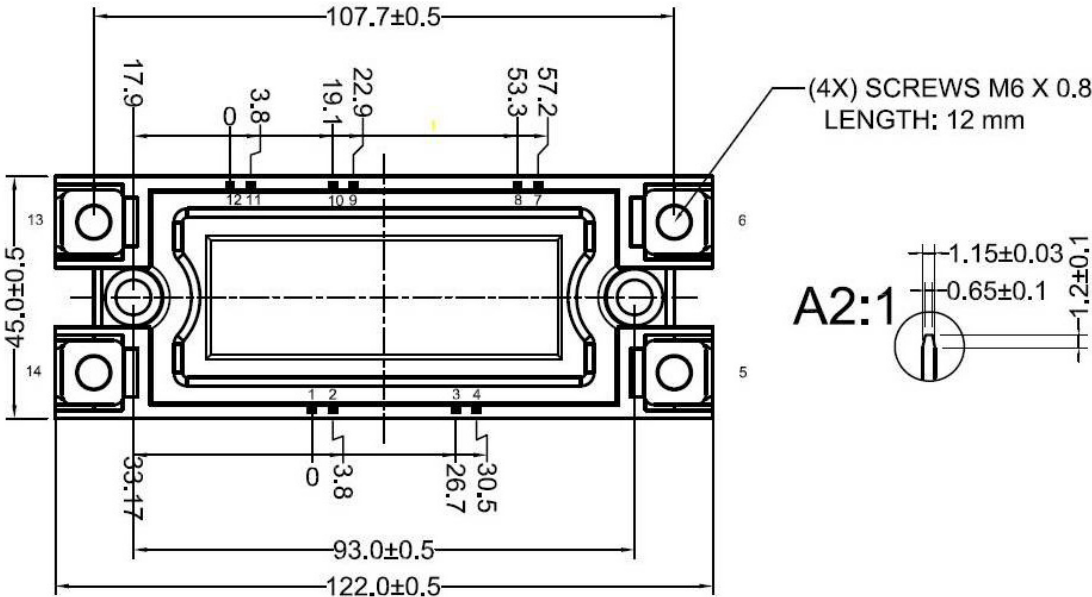
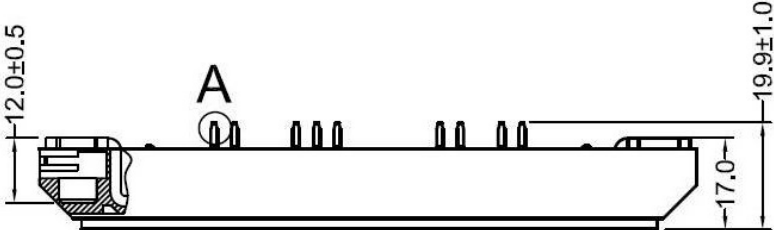

Figure12. Circuit Diagram



Dimensions (mm)
Figure13. Package Outline