

FEATURES

- High level of integration
- IGBT³ CHIP(Trench+Field Stop technology)
- Low saturation voltage and positive temperature coefficient
- Fast switching and short tail current
- Free wheeling diodes with fast and soft reverse recovery
- Solderable pins for PCB mounting
- Temperature sense included

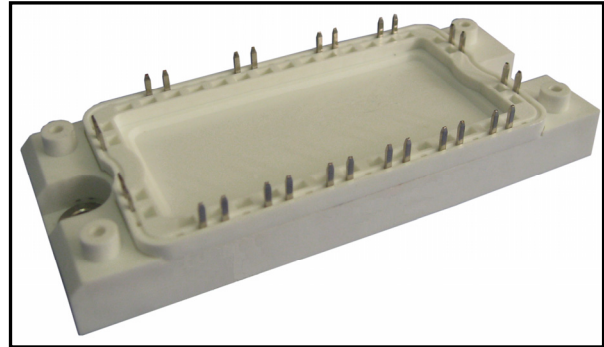

APPLICATIONS

- AC motor control
- Motion/servo control
- Inverter and power supplies

INVERTER SECTOR

ABSOLUTE MAXIMUM RATINGS

T_c=25°C unless otherwise specified

Symbol	Parameter	Test Conditions	Values	Unit
IGBT				
V _{CES}	Collector - Emitter Voltage	T _{vj} =25°C	1200	V
V _{GES}	Gate - Emitter Voltage		±20	V
I _c	DC Collector Current	T _c =25°C	40	A
		T _c =80°C	25	A
I _{CM}	Repetitive Peak Collector Current	t _p =1ms	50	A
P _{tot}	Power Dissipation Per IGBT		147	W
Diode				
V _{RRM}	Repetitive Reverse Voltage	T _{vj} =25°C	1200	V
I _{F(AV)}	Average Forward Current	T _c =25°C	35	A
		T _c =80°C	25	A
I _{FRM}	Repetitive Peak Forward Current	t _p =1ms	50	A
I ² t		T _{vj} =125°C, t=10ms, V _R =0V	200	A ² s

MMG25H120X6TN

INVERTER SECTOR

ELECTRICAL AND THERMAL CHARACTERISTICS

$T_C=25^{\circ}\text{C}$ unless otherwise specified

Symbol	Parameter	Test Conditions	Min.	Typ.	Max.	Unit
IGBT						
$V_{GE(th)}$	Gate - Emitter Threshold Voltage	$V_{CE}=V_{GE}, I_C=1\text{mA}$	5.0	5.8	6.5	V
$V_{CE(sat)}$	Collector - Emitter Saturation Voltage	$I_C=25\text{A}, V_{GE}=15\text{V}, T_{VJ}=25^{\circ}\text{C}$		1.7		V
		$I_C=25\text{A}, V_{GE}=15\text{V}, T_{VJ}=125^{\circ}\text{C}$		1.9		V
I_{CES}	Collector Leakage Current	$V_{CE}=1200\text{V}, V_{GE}=0\text{V}, T_{VJ}=25^{\circ}\text{C}$			0.1	mA
		$V_{CE}=1200\text{V}, V_{GE}=0\text{V}, T_{VJ}=125^{\circ}\text{C}$			1	mA
I_{GES}	Gate Leakage Current	$V_{CE}=0\text{V}, V_{GE} \pm 15\text{V}, T_{VJ}=125^{\circ}\text{C}$	-400		400	nA
R_{Gint}	Integrated Gate Resistor			8.0		Ω
Q_{ge}	Gate Charge	$V_{CE}=600\text{V}, I_C=25\text{A}, V_{GE} = \pm 15\text{V}$		0.24		μC
C_{ies}	Input Capacitance	$V_{CE}=25\text{V}, V_{GE}=0\text{V}, f=1\text{MHz}$		1.81		nF
C_{res}	Reverse Transfer Capacitance				0.08	
$t_{d(on)}$	Turn - on Delay Time	$V_{CC}=600\text{V}, I_C=25\text{A},$ $R_G = 36 \Omega,$	$T_{VJ} = 25^{\circ}\text{C}$	90		ns
			$T_{VJ} = 125^{\circ}\text{C}$	90		ns
t_r	Rise Time	$V_{GE} = \pm 15\text{V},$ Inductive Load	$T_{VJ} = 25^{\circ}\text{C}$	30		ns
			$T_{VJ} = 125^{\circ}\text{C}$	50		ns
$t_{d(off)}$	Turn - off Delay Time	$V_{CC}=600\text{V}, I_C=25\text{A},$ $R_G = 36 \Omega,$	$T_{VJ} = 25^{\circ}\text{C}$	420		ns
			$T_{VJ} = 125^{\circ}\text{C}$	520		ns
t_f	Fall Time	$V_{GE} = \pm 15\text{V},$ Inductive Load	$T_{VJ} = 25^{\circ}\text{C}$	70		ns
			$T_{VJ} = 125^{\circ}\text{C}$	90		ns
E_{on}	Turn - on Energy	$V_{CC}=600\text{V}, I_C=25\text{A},$ $R_G = 36 \Omega,$	$T_{VJ} = 25^{\circ}\text{C}$	2.4		mJ
			$T_{VJ} = 125^{\circ}\text{C}$	3.5		mJ
E_{off}	Turn - off Energy	$V_{GE} = \pm 15\text{V},$ Inductive Load	$T_{VJ} = 25^{\circ}\text{C}$	1.8		mJ
			$T_{VJ} = 125^{\circ}\text{C}$	2.1		mJ
I_{sc}	Short Circuit Current	$t_{psc} \leq 10\mu\text{s}, V_{GE}=15\text{V}$ $T_{VJ}=125^{\circ}\text{C}, V_{CC}=900\text{V}$		100		A
R_{thJC}	Junction-to-Case Thermal Resistance (Per IGBT)				0.85	K /W
Diode						
V_F	Forward Voltage	$I_F=25\text{A}, V_{GE}=0\text{V}, T_{VJ} = 25^{\circ}\text{C}$		1.55		V
		$I_F=25\text{A}, V_{GE}=0\text{V}, T_{VJ} = 125^{\circ}\text{C}$		1.54		V
t_{rr}	Reverse Recovery Time	$I_F=25\text{A}, V_R=600\text{V}$		200		ns
I_{RRM}	Max. Reverse Recovery Current	$di_F/dt=-400\text{A}/\mu\text{s}$		20		A
E_{rec}	Reverse Recovery Energy	$T_{VJ} = 125^{\circ}\text{C}$		1.5		mJ
R_{thJCD}	Junction-to-Case Thermal Resistance (Per Diode)				1.4	K /W

NTC SECTOR

CHARACTERISTIC VALUES

$T_C=25^{\circ}\text{C}$ unless otherwise specified

Symbol	Parameter	Test Conditions	Min.	Typ.	Max.	Unit
R ₂₅	Resistance	T _C = 25°C		5		KΩ
B _{25/50}				3375		K

MODULE CHARACTERISTICS

$T_C=25^{\circ}\text{C}$ unless otherwise specified

Symbol	Parameter	Test Conditions	Min.	Typ.	Max.	Unit
T _{Vj max}	Max. Junction Temperature				150	°C
T _{Vj op}	Operating Temperature		-40		125	°C
T _{stg}	Storage Temperature		-40		125	°C
V _{isol}	Insulation Test Voltage	AC, t=1min		3000		V
CTI	Comparative Tracking Index		250			
M _d	Mounting Torque	Recommended (M5)	2.5		5	N · m
Weight				180		g

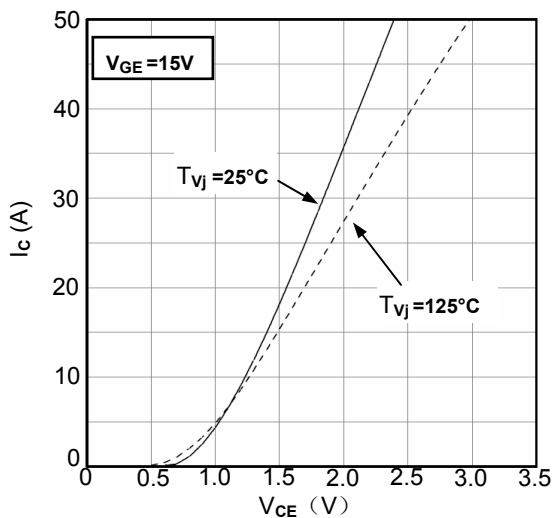

Figure1. Typical Output Characteristics IGBT-inverter

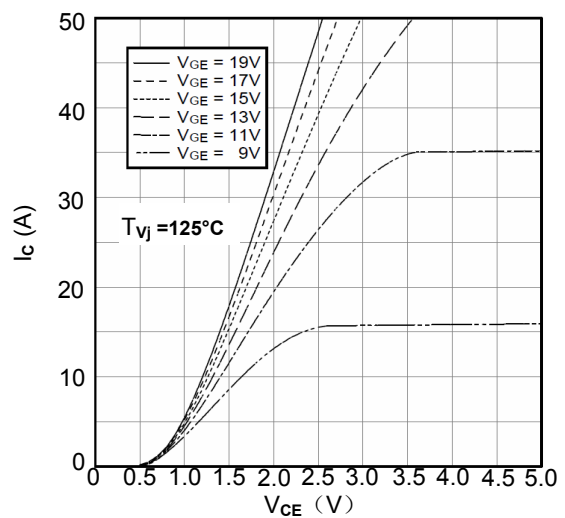

Figure2. Typical Output Characteristics IGBT-inverter

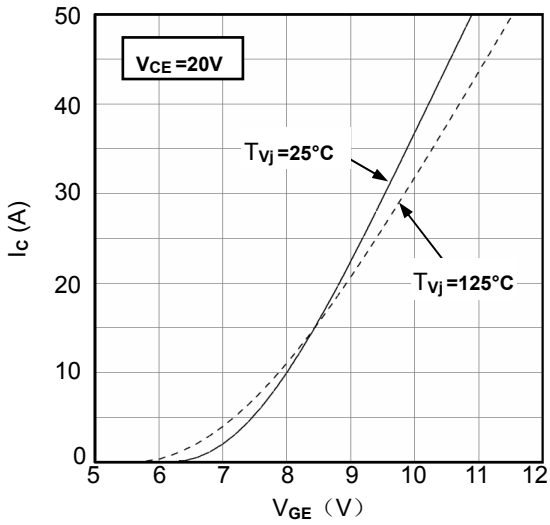

Figure3. Typical Transfer characteristics IGBT-inverter

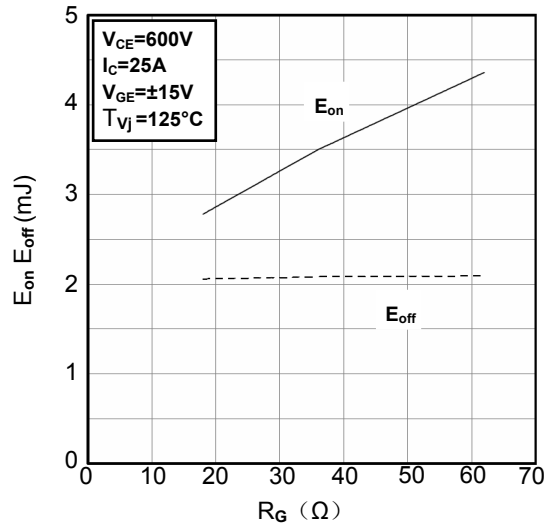

Figure4. Switching Energy vs. Gate Resistor IGBT-inverter

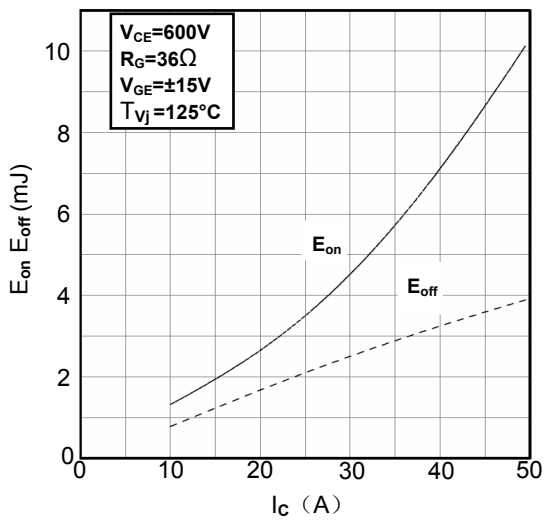

Figure5. Switching Energy vs. Collector Current IGBT-inverter

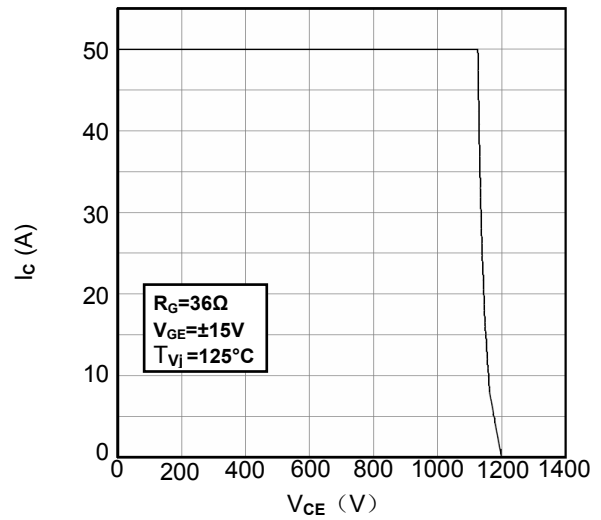

Figure6. Reverse Biased Safe Operating Area IGBT-inverter

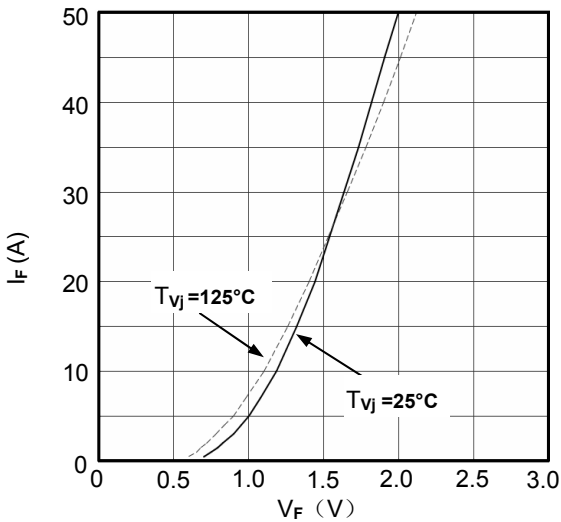

Figure7. Diode Forward Characteristics Diode -inverter

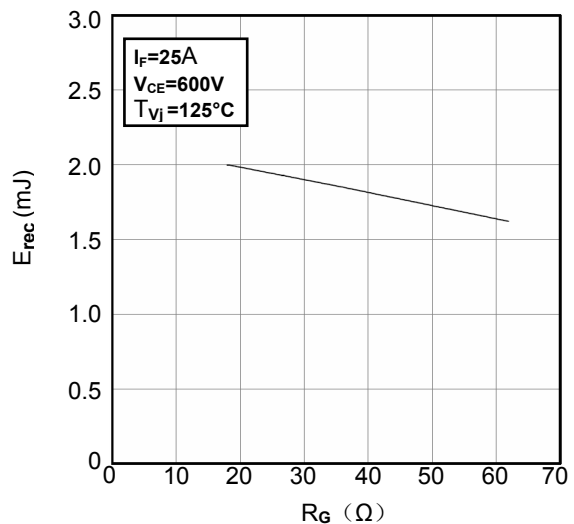

Figure8. Switching Energy vs. Gate Resistor Diode -inverter

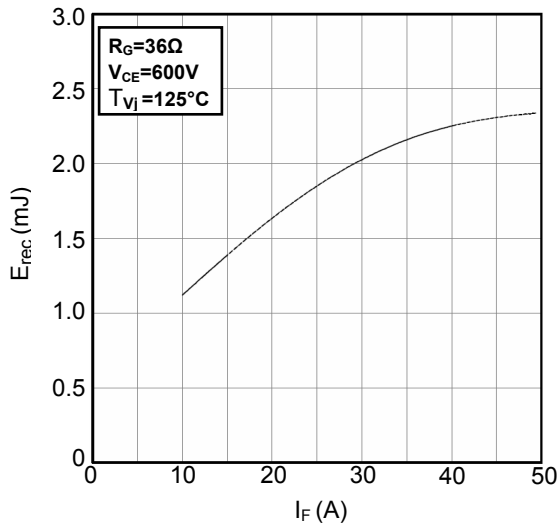

Figure9. Switching Energy vs. Forward Current Diode-inverter

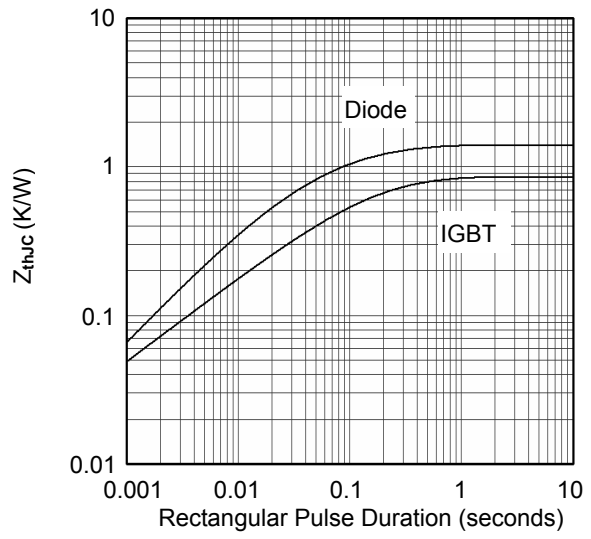

Figure10. Transient Thermal Impedance of Diode and IGBT-inverter

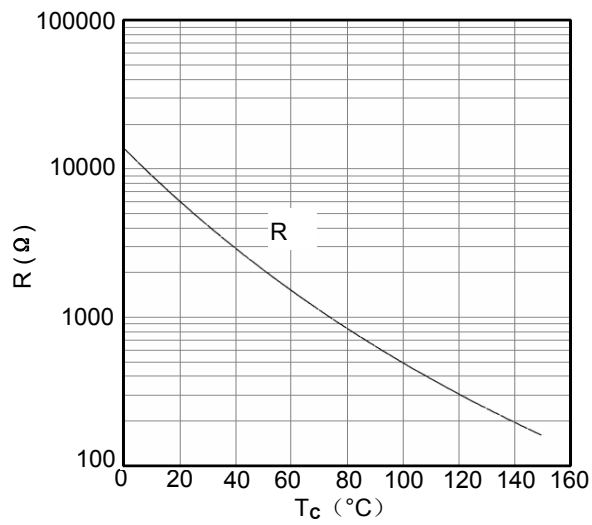

Figure11. NTC Characteristics

MMG25H120X6TN

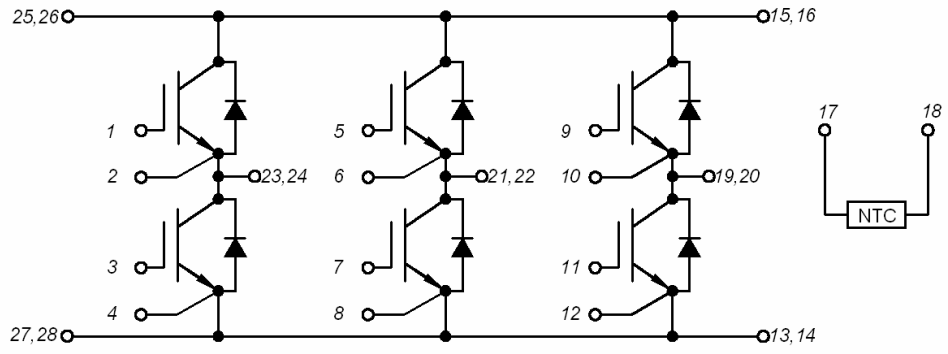
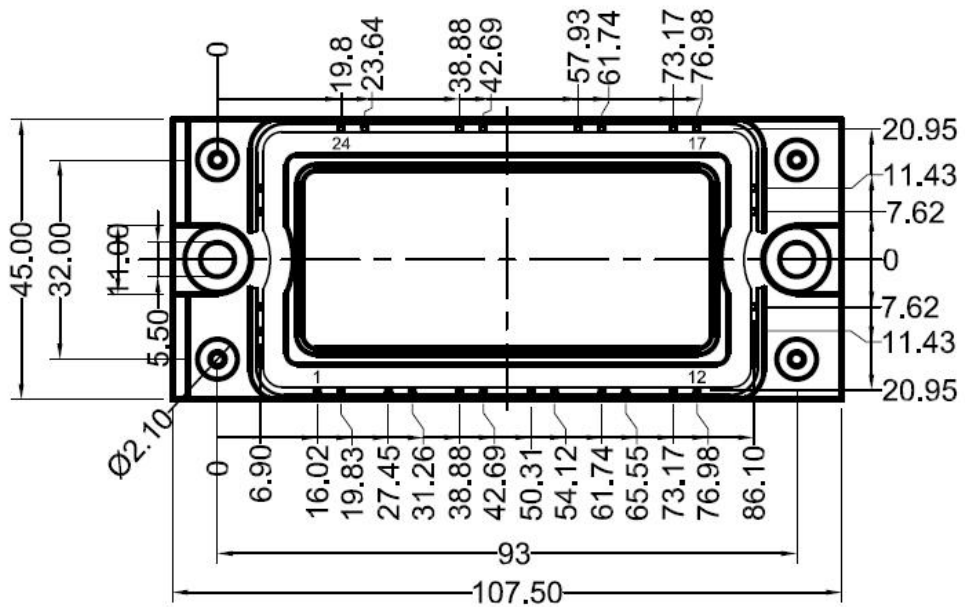
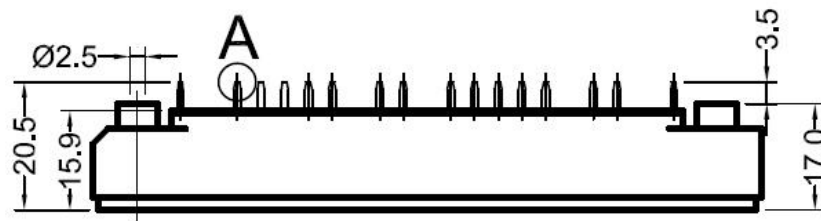

Figure12. Circuit Diagram



Dimensions (mm)
Figure13. Package Outline