

## FEATURES

- Ultra Low Loss
- High Ruggedness
- High Short Circuit Capability
- Positive Temperature Coefficient
- With Fast Free-Wheeling Diodes

## APPLICATIONS

- Invector
- Converter
- Welder
- SMPS and UPS
- Induction Heating



## ABSOLUTE MAXIMUM RATINGS

$T_C=25^{\circ}\text{C}$  unless otherwise specified

Symbol	Parameter	Test Conditions	Values	Unit
<b>IGBT</b>				
$V_{CES}$	Collector - Emitter Voltage		600	V
$V_{GES}$	Gate - Emitter Voltage		$\pm 20$	V
$I_C$	DC Collector Current	$T_C=25^{\circ}\text{C}$	150	A
		$T_C=80^{\circ}\text{C}$	105	A
$I_{Cpuls}$	Pulsed Collector Current	$T_C=25^{\circ}\text{C}, t_p=1\text{ms}$	300	A
		$T_C=80^{\circ}\text{C}, t_p=1\text{ms}$	210	A
$P_{tot}$	Power Dissipation Per IGBT		625	W
$T_J$	Junction Temperature Range		-40 to +150	$^{\circ}\text{C}$
$T_{STG}$	Storage Temperature Range		-40 to +125	$^{\circ}\text{C}$
$V_{isol}$	Insulation Test Voltage	AC, $t=1\text{min}$	3000	V
<b>Free-Wheeling Diode</b>				
$V_{RRM}$	Repetitive Reverse Voltage		600	V
$I_{F(AV)}$	Average Forward Current	$T_C=25^{\circ}\text{C}$	125	A
		$T_C=80^{\circ}\text{C}$	85	A
$I_{F(RMS)}$	RMS Forward Current		122	A
$I_{FSM}$	Non-Repetitive Surge	$T_J=45^{\circ}\text{C}, t=10\text{ms}, \text{Sine}$	500	A
	Forward Current	$T_J=45^{\circ}\text{C}, t=8.3\text{ms}, \text{Sine}$	545	A

# MMG100SR060UZK

## ELECTRICAL CHARACTERISTICS

T<sub>C</sub>=25°C unless otherwise specified

Symbol	Parameter	Test Conditions	Min.	Typ.	Max.	Unit
<b>IGBT</b>						
V <sub>GE(th)</sub>	Gate - Emitter Threshold Voltage	V <sub>CE</sub> =V <sub>GE</sub> , I <sub>C</sub> =250μA	3.5		5.5	V
V <sub>CE(sat)</sub>	Collector - Emitter Saturation Voltage	I <sub>C</sub> =100A, V <sub>GE</sub> =15V, T <sub>J</sub> =25°C		1.9		V
		I <sub>C</sub> =100A, V <sub>GE</sub> =15V, T <sub>J</sub> =125°C		2.1		V
I <sub>CES</sub>	Collector Leakage Current	V <sub>CE</sub> =600V, V <sub>GE</sub> =0V, T <sub>J</sub> =25°C			0.5	mA
		V <sub>CE</sub> =600V, V <sub>GE</sub> =0V, T <sub>J</sub> =125°C		3		mA
I <sub>GES</sub>	Gate Leakage Current	V <sub>CE</sub> =0V, V <sub>GE</sub> =±20V	-1.1		1.1	μA
Q <sub>ge</sub>	Gate Charge	V <sub>CC</sub> =300V, I <sub>C</sub> =100A, V <sub>GE</sub> =±15V		230		nC
C <sub>ies</sub>	Input Capacitance	V <sub>CE</sub> =25V, V <sub>GE</sub> =0V, f=1MHz		5.3		nF
C <sub>oes</sub>	Output Capacitance			0.52		nF
C <sub>res</sub>	Reverse Transfer Capacitance			0.34		nF
t <sub>d(on)</sub>	Turn - on Delay Time	V <sub>CC</sub> =300V, I <sub>C</sub> =100A		45		ns
t <sub>r</sub>	Rise Time	R <sub>G</sub> = 10 Ω, V <sub>GE</sub> =±15V		45		ns
t <sub>d(off)</sub>	Turn - off Delay Time	T <sub>J</sub> =25°C		320		ns
t <sub>f</sub>	Fall Time	Inductive Load		35		ns
t <sub>d(on)</sub>	Turn - on Delay Time	V <sub>CC</sub> =300V, I <sub>C</sub> =100A		50		ns
t <sub>r</sub>	Rise Time	R <sub>G</sub> = 10 Ω, V <sub>GE</sub> =±15V		45		ns
t <sub>d(off)</sub>	Turn - off Delay Time	T <sub>J</sub> =125°C		350		ns
t <sub>f</sub>	Fall Time	Inductive Load		40		ns
E <sub>on</sub>	Turn - on Switching Energy	V <sub>CC</sub> =300V, I <sub>C</sub> =100A, T <sub>J</sub> =25°C		3.5		mJ
		R <sub>G</sub> = 10 Ω, T <sub>J</sub> =125°C		4.5		mJ
E <sub>off</sub>	Turn - off Switching Energy	V <sub>GE</sub> =±15V, T <sub>J</sub> =25°C		2.5		mJ
		Inductive Load, T <sub>J</sub> =125°C		3.5		mJ
<b>Free-Wheeling Diode</b>						
V <sub>F</sub>	Forward Voltage	I <sub>F</sub> =100A, V <sub>GE</sub> =0V, T <sub>J</sub> =25°C		1.9	2.2	V
		I <sub>F</sub> =100A, V <sub>GE</sub> =0V, T <sub>J</sub> =125°C		1.7	2.0	V
t <sub>rr</sub>	Reverse Recovery Time	I <sub>F</sub> =100A, V <sub>R</sub> =400V		50		ns
I <sub>RRM</sub>	Max. Reverse Recovery Current	di <sub>F</sub> /dt=-1000A/μs		45		A
Q <sub>rr</sub>	Reverse Recovery Charge	T <sub>J</sub> =125°C		1.5		μC

## THERMAL AND MECHANICAL CHARACTERISTICS

Symbol	Parameter	Test Conditions	Min.	Typ.	Max.	Unit
R <sub>thJC</sub>	Junction-to-Case Thermal Resistance	Per IGBT			0.2	K /W
R <sub>thJCD</sub>	Junction-to-Case Thermal Resistance	Per Inverse Diode			0.5	K /W
Torque	Module-to-Sink	Recommended (M6)	3		5	N · m
Torque	Module Electrodes	Recommended (M5)	2.5		5	N · m
Weight				150		g

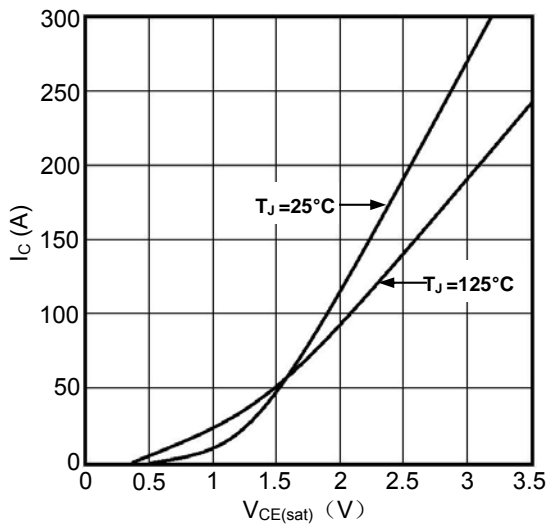

Figure1. Typical Output characteristics

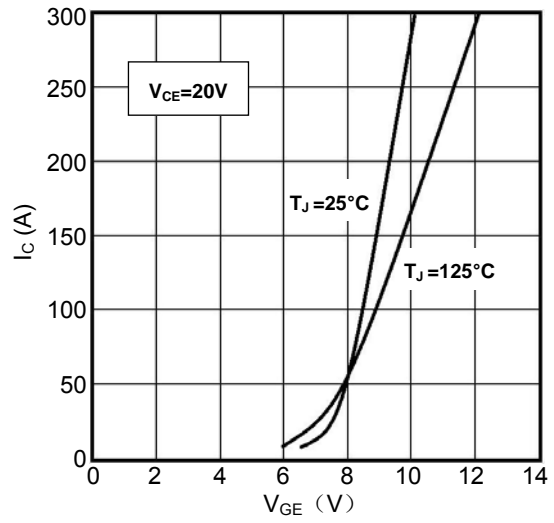

Figure2. Typical Transfer characteristics

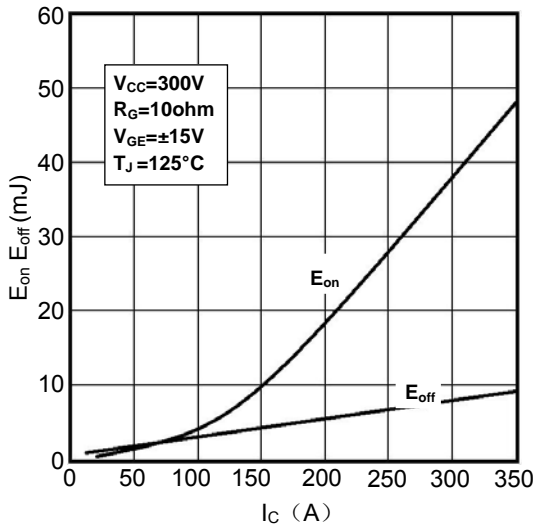

Figure3. Switching Energy vs. Collector Current

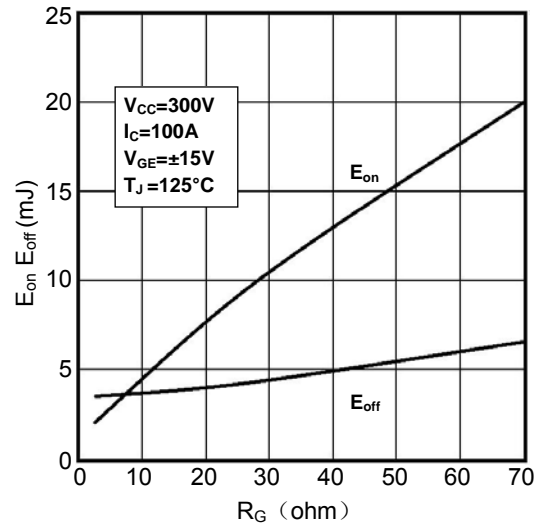

Figure4. Switching Energy vs. Gate Resistor

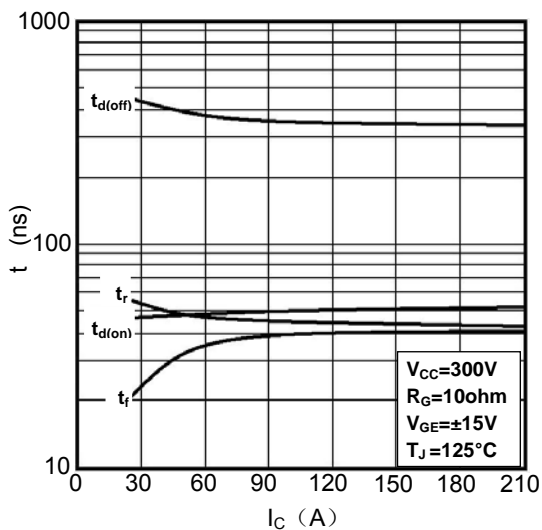

Figure5. Switching Times vs. Collector Current

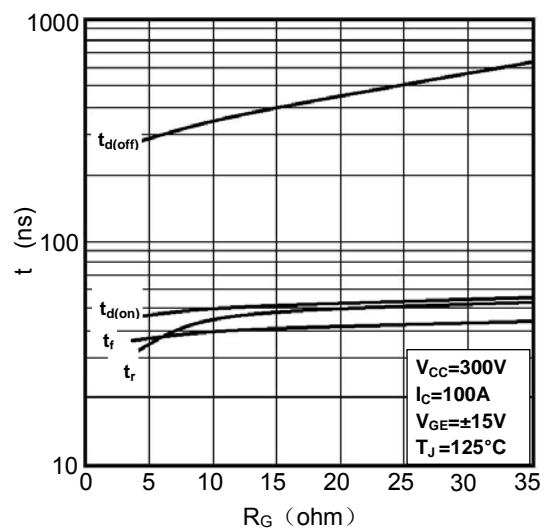

Figure6. Switching Times vs. Gate Resistor

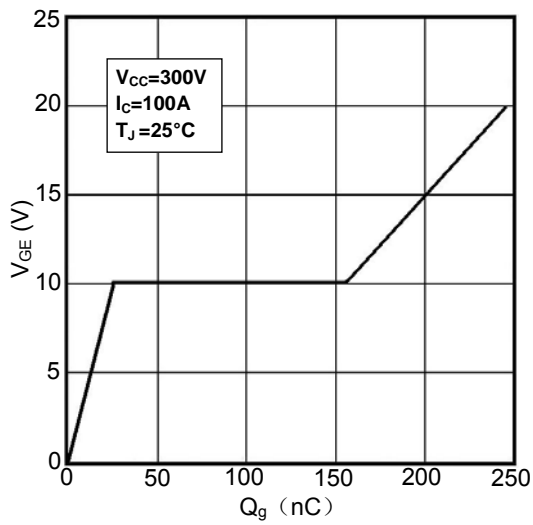

Figure7. Gate Charge characteristics

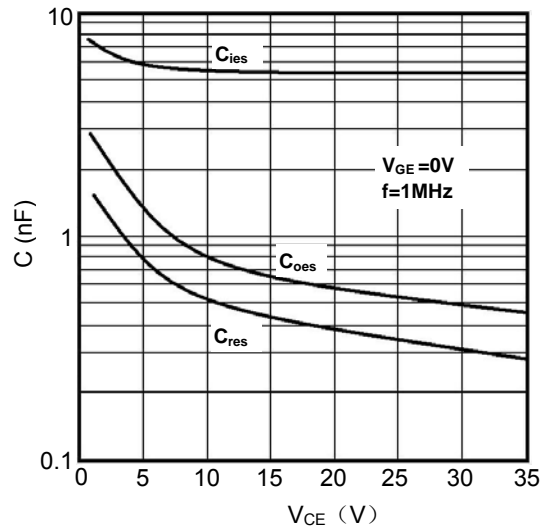

Figure8. Typical Capacitances vs.  $V_{CE}$

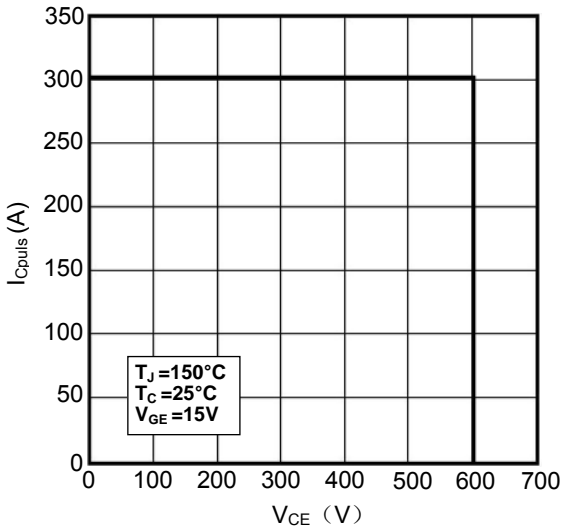

Figure9. Reverse Biased Safe Operating Area

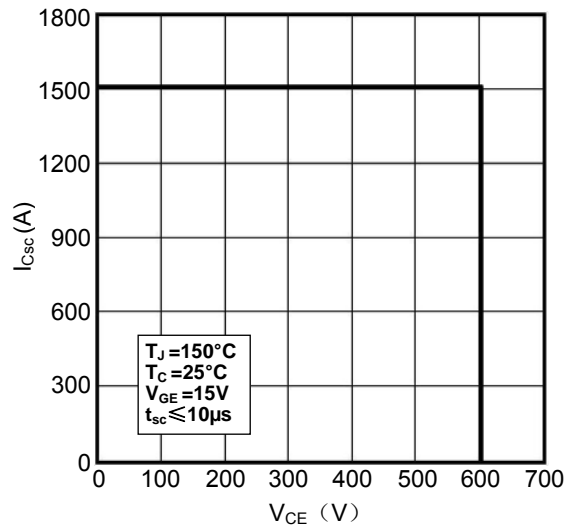

Figure10. Short Circuit Safe Operating Area

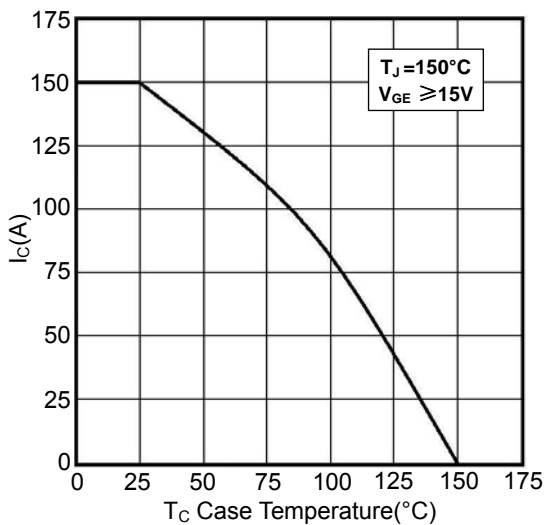

Figure11. Rated Current vs.  $T_C$

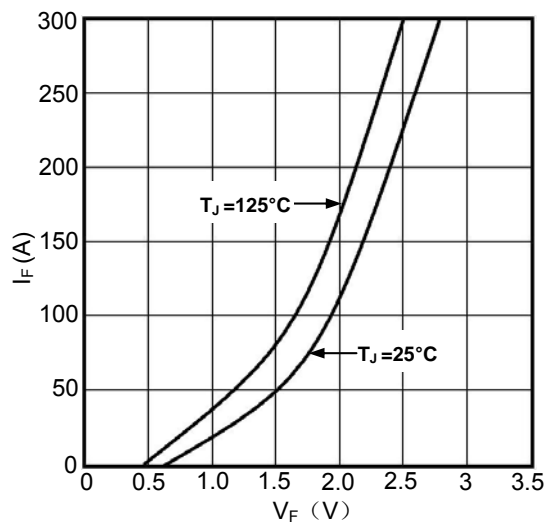
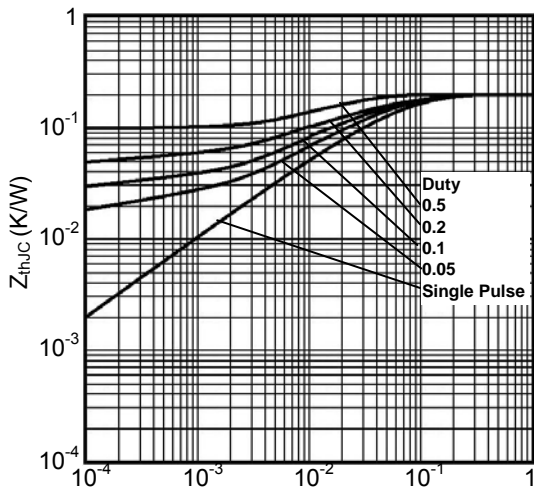
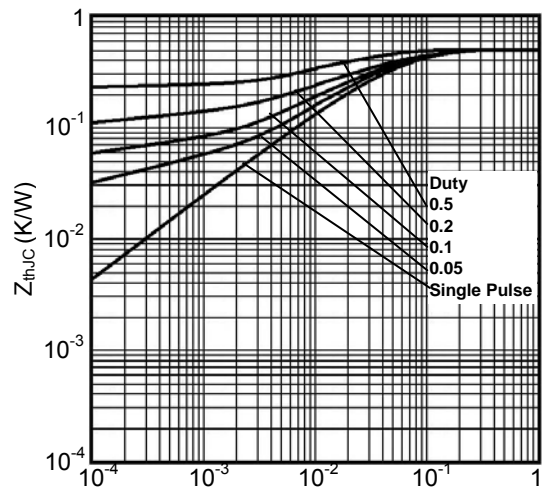

Figure12. Diode Forward Characteristics



Rectangular Pulse Duration (seconds)  
Figure13. Transient Thermal Impedance of IGBT



Rectangular Pulse Duration (seconds)  
Figure14. Transient Thermal Impedance of Diode

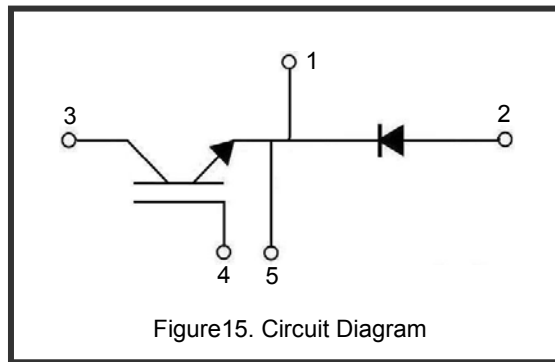

Figure15. Circuit Diagram

