

## PRODUCT FEATURES

- Ultrafast Reverse Recovery Time
- Soft Reverse Recovery Characteristics
- Low Reverse Recovery Loss
- Low Forward Voltage
- High Surge Current Capability
- Low Inductance Package



## APPLICATIONS

- Inversion Welder
- Uninterruptible Power Supply (UPS)
- Plating Power Supply
- Ultrasonic Cleaner and Welder
- Converter & Chopper
- Power Factor Correction (PFC) Circuit

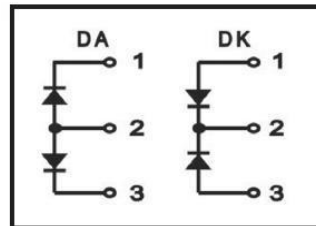

## ABSOLUTE MAXIMUM RATINGS

$T_C=25^{\circ}\text{C}$  unless otherwise specified

Symbol	Parameter	Test Conditions	Values	Unit
$V_R$	Maximum D.C. Reverse Voltage		900	V
$V_{RRM}$	Maximum Repetitive Reverse Voltage		900	V
$I_{F(AV)}$	Average Forward Current	$T_C=90^{\circ}\text{C}$ , Per Diode	100	A
		$T_C=90^{\circ}\text{C}$ , Per Moudle	200	A
		$T_C=90^{\circ}\text{C}$ , 20KHz, Per Moudle	141	A
$I_{F(RMS)}$	RMS Forward Current	$T_C=90^{\circ}\text{C}$ , Per Diode	141	A
$I_{FSM}$	Non-Repetitive Surge Forward Current	$T_J=45^{\circ}\text{C}$ , $t=10\text{ms}$ , 50Hz, Sine	1080	A
		$T_J=45^{\circ}\text{C}$ , $t=8.3\text{ms}$ , 60Hz, Sine	1160	A
$I^2t$	$I^2t$ (For Fusing)	$T_J=45^{\circ}\text{C}$ , $t=10\text{ms}$ , 50Hz, Sine	5832	$\text{A}^2\text{s}$
		$T_J=45^{\circ}\text{C}$ , $t=8.3\text{ms}$ , 60Hz, Sine	6728	$\text{A}^2\text{s}$
$P_D$	Power Dissipation		360	W
$T_J$	Junction Temperature		-40 to +150	$^{\circ}\text{C}$
$T_{STG}$	Storage Temperature Range		-40 to +125	$^{\circ}\text{C}$
$V_{ISOL}$	Insulation Test Voltage	AC, $t=1\text{min}$	3000	V
Torque	Module-to-Sink	Recommended (M5)	2.5~4	N·m
Torque	Module Electrodes	Recommended (M5)	2.5~4	N·m
$R_{\theta JC}$	Thermal Resistance	Junction-to-Case	0.35	$^{\circ}\text{C}/\text{W}$
Weight			100	g

**ELECTRICAL CHARACTERISTICS**

$T_C=25^\circ\text{C}$  unless otherwise specified

Symbol	Parameter	Test Conditions	Min.	Typ.	Max.	Unit
$I_{RM}$	Reverse Leakage Current	$V_R=900\text{V}$	--	--	1	mA
		$V_R=900\text{V}, T_J=125^\circ\text{C}$	--	--	5	mA
$V_F$	Forward Voltage	$I_F=100\text{A}$	--	2.75	--	V
		$I_F=100\text{A}, T_J=125^\circ\text{C}$	--	1.9	--	V
$t_{rr}$	Reverse Recovery Time	$I_F=1\text{A}, V_R=30\text{V}, di_F/dt=-200\text{A}/\mu\text{s}$	--	42	--	ns
$t_{rr}$	Reverse Recovery Time	$V_R=450\text{V}, I_F=100\text{A}$	--	65	--	ns
$I_{RRM}$	Max. Reverse Recovery Current		$di_F/dt=-200\text{A}/\mu\text{s}, T_J=25^\circ\text{C}$	--	6	--
$t_{rr}$	Reverse Recovery Time	$V_R=450\text{V}, I_F=100\text{A}$	--	175	--	ns
$I_{RRM}$	Max. Reverse Recovery Current		$di_F/dt=-200\text{A}/\mu\text{s}, T_J=125^\circ\text{C}$	--	13.5	--

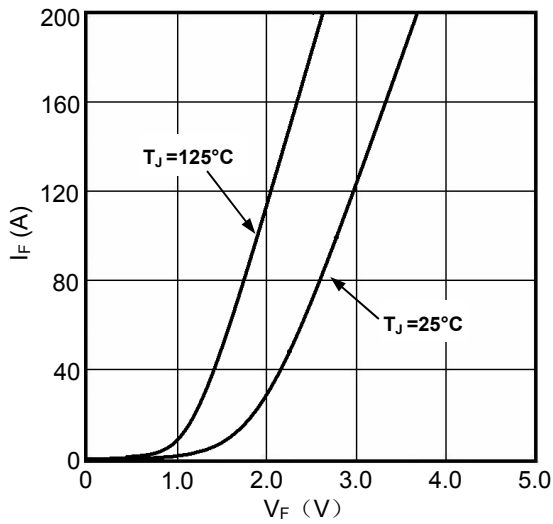

Figure1. Forward Voltage Drop vs Forward Current

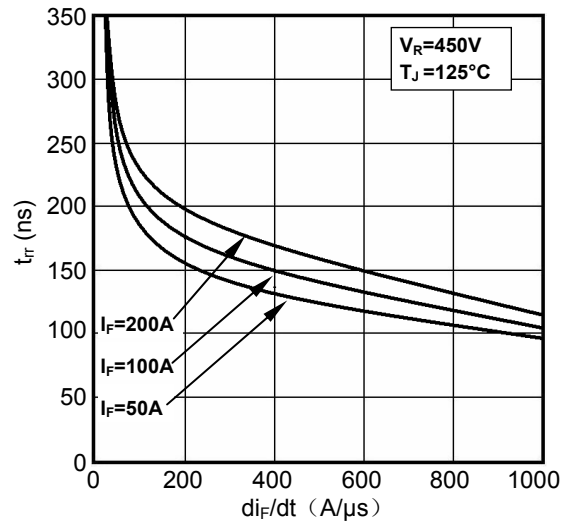

Figure2. Reverse Recovery Time vs  $di_F/dt$

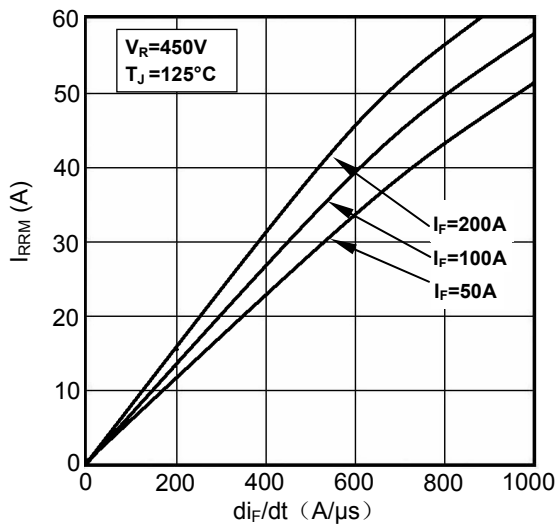

Figure3. Reverse Recovery Current vs  $di_F/dt$

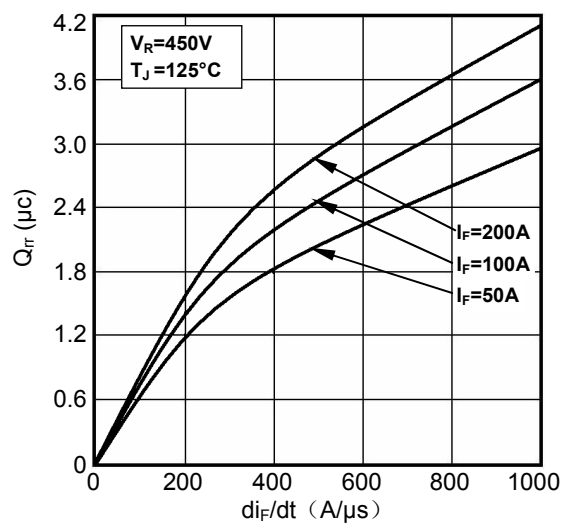

Figure4. Reverse Recovery Charge vs  $di_F/dt$

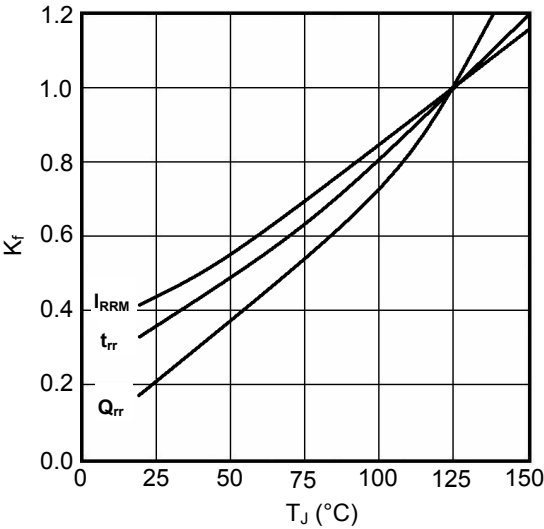

Figure5. Dynamic Parameters vs Junction Temperature

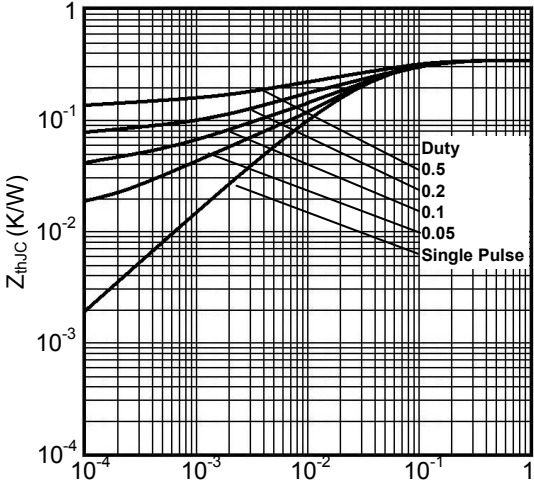
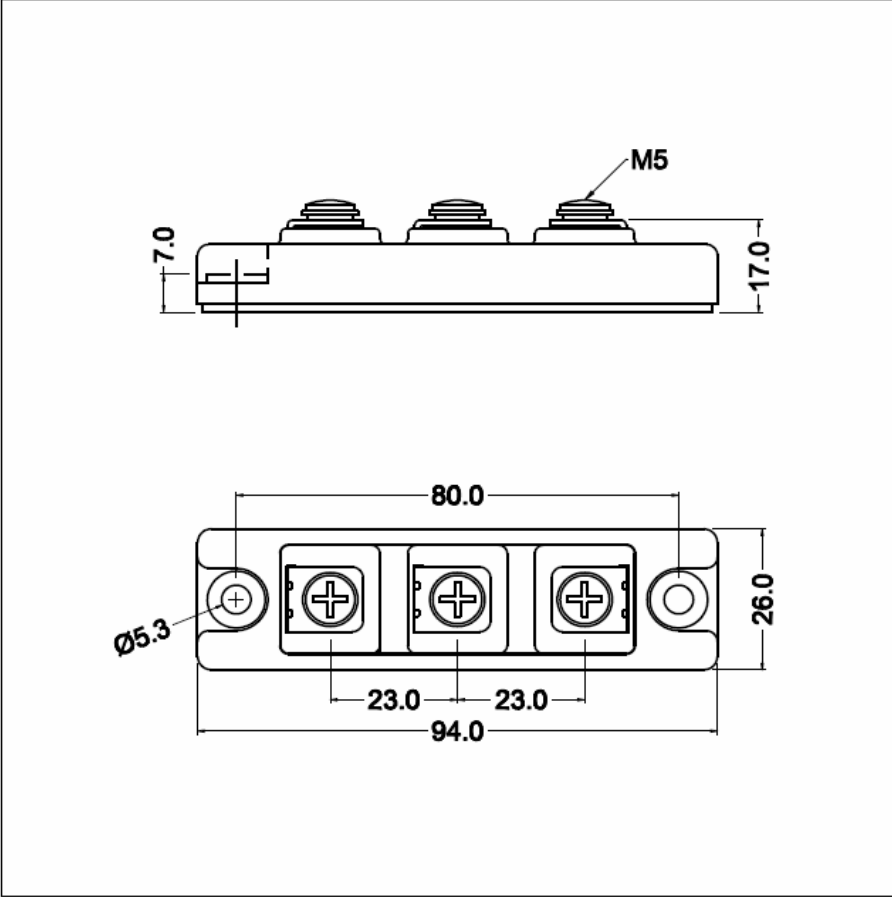

Figure6. Transient Thermal Impedance



Dimensions (mm)  
 Figure7. Package Outline