

## PRODUCT FEATURES

- Ultrafast Reverse Recovery Time
- Soft Reverse Recovery Characteristics
- Low Reverse Recovery Loss
- Electrically Isolated by DBC Ceramic
- High System Power Density
- Popular SOT-227 Package



## APPLICATIONS

- Inversion Welder
- Uninterruptible Power Supply (UPS)
- Plating Power Supply
- Ultrasonic Cleaner and Welder
- Converter & Chopper
- Power Factor Correction (PFC) Circuit

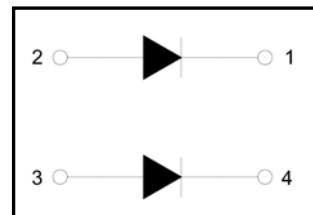

## ABSOLUTE MAXIMUM RATINGS

$T_C=25^{\circ}\text{C}$  unless otherwise specified

Symbol	Parameter	Test Conditions	Values	Unit
$V_R$	Maximum D.C. Reverse Voltage		700	V
$V_{RRM}$	Maximum Repetitive Reverse Voltage		700	V
$I_{F(AV)}$	Average Forward Current	$T_C=90^{\circ}\text{C}$ , Per Diode	60	A
		$T_C=90^{\circ}\text{C}$ , Per Module	120	A
		$T_C=90^{\circ}\text{C}$ , 20KHz, Per Module	80	A
$I_{F(RMS)}$	RMS Forward Current	$T_C=90^{\circ}\text{C}$ , Per Diode	85	A
$I_{FSM}$	Non-Repetitive Surge Forward Current	$T_J=45^{\circ}\text{C}$ , $t=10\text{ms}$ , 50Hz, Sine	600	A
		$T_J=45^{\circ}\text{C}$ , $t=8.3\text{ms}$ , 60Hz, Sine	700	A
$I^2t$	$I^2t$ (For Fusing)	$T_J=45^{\circ}\text{C}$ , $t=10\text{ms}$ , 50Hz, Sine	1800	$\text{A}^2\text{s}$
		$T_J=45^{\circ}\text{C}$ , $t=8.3\text{ms}$ , 60Hz, Sine	2450	$\text{A}^2\text{s}$
$P_D$	Power Dissipation		208	W
$T_J$	Junction Temperature		-40 to +150	$^{\circ}\text{C}$
$T_{STG}$	Storage Temperature Range		-40 to +125	$^{\circ}\text{C}$
$V_{isol}$	Insulation Test Voltage	AC, $t=1\text{min}$	3000	V
Torque	Module-to-Sink	Recommended (M4)	0.7~1.1	N·m
Torque	Module Electrodes	Recommended (M4)	0.7~1.1	N·m
$R_{\theta JC}$	Thermal Resistance	Junction-to-Case	0.6	$^{\circ}\text{C}/\text{W}$
Weight			26.5	g

**ELECTRICAL CHARACTERISTICS**

T<sub>C</sub>=25°C unless otherwise specified

Symbol	Parameter	Test Conditions	Min.	Typ.	Max.	Unit
I <sub>RM</sub>	Reverse Leakage Current	V <sub>R</sub> =700V	--	--	1	mA
		V <sub>R</sub> =700V, T <sub>J</sub> =125°C	--	--	2	mA
V <sub>F</sub>	Forward Voltage	I <sub>F</sub> =60A	--	1.57	2.0	V
		I <sub>F</sub> =60A, T <sub>J</sub> =125°C	--	--	1.7	V
t <sub>rr</sub>	Reverse Recovery Time	I <sub>F</sub> =1A, V <sub>R</sub> =30V, di <sub>F</sub> /dt=-200A/μs	--	30	--	ns
t <sub>rr</sub>	Reverse Recovery Time	V <sub>R</sub> =350V, I <sub>F</sub> =60A	--	70	--	ns
I <sub>RRM</sub>	Max. Reverse Recovery Current		di <sub>F</sub> /dt=-200A/μs, T <sub>J</sub> =25°C	--	7.1	--
t <sub>rr</sub>	Reverse Recovery Time	V <sub>R</sub> =350V, I <sub>F</sub> =60A	--	130	--	ns
I <sub>RRM</sub>	Max. Reverse Recovery Current		di <sub>F</sub> /dt=-200A/μs, T <sub>J</sub> =125°C	--	16	--

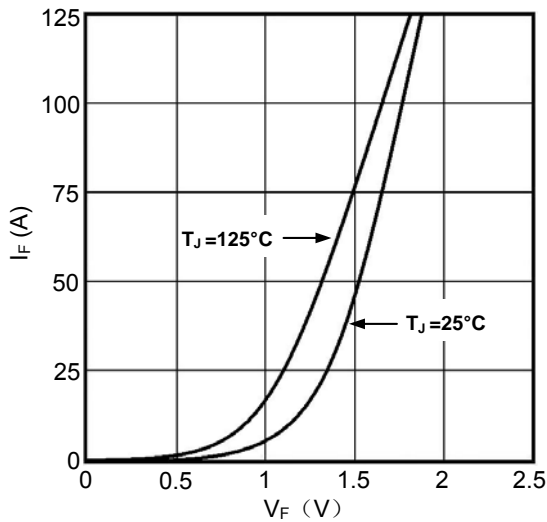

Figure1. Forward Voltage Drop vs Forward Current

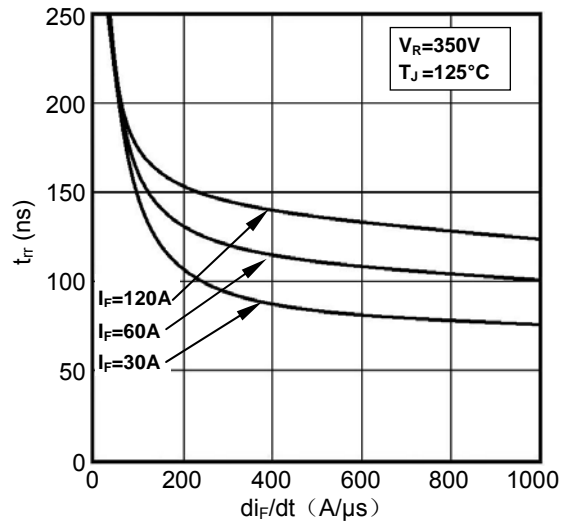

Figure2. Reverse Recovery Time vs di<sub>F</sub>/dt

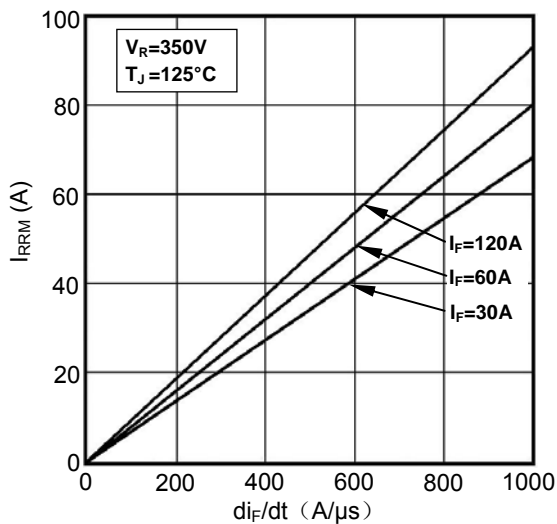

Figure3. Reverse Recovery Current vs di<sub>F</sub>/dt

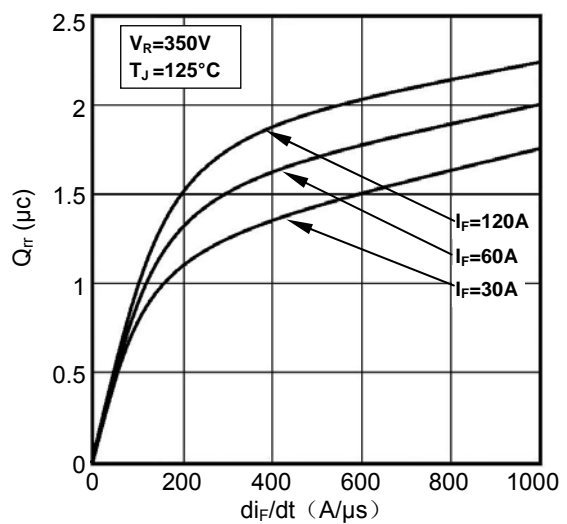

Figure4. Reverse Recovery Charge vs di<sub>F</sub>/dt

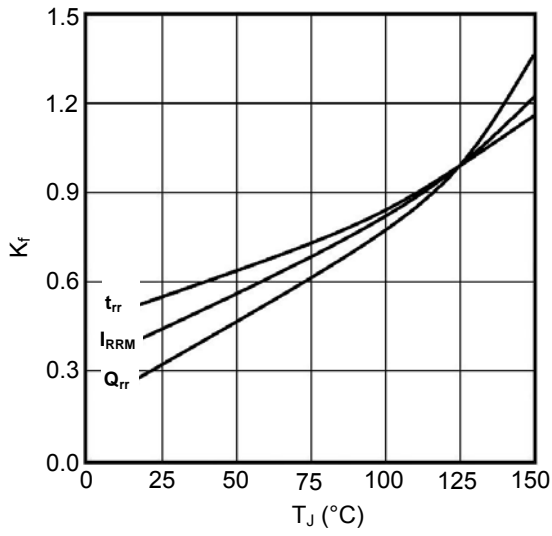

Figure5. Dynamic Parameters vs Junction Temperature

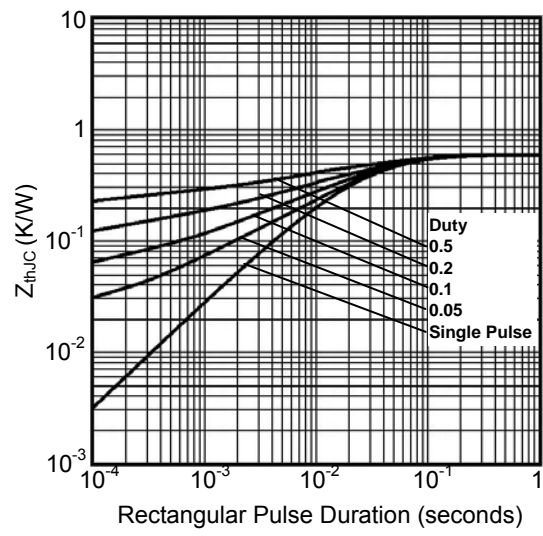
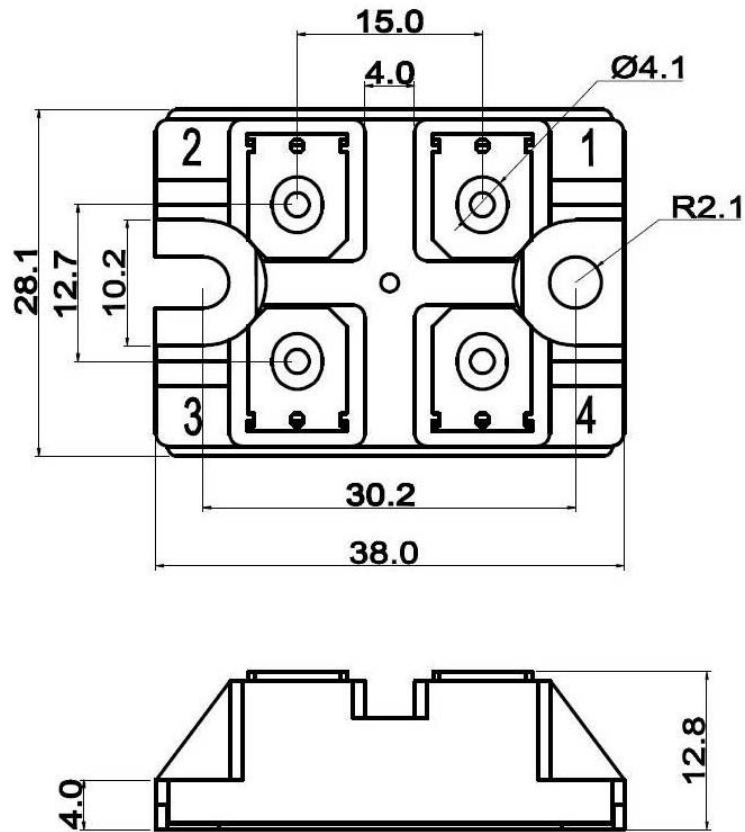

Figure6. Transient Thermal Impedance



Dimensions (mm)  
Figure7. Package Outline