

MTP3N50E

Designer's™ Data Sheet

TMOS E-FET™

High Energy Power FET

N-Channel Enhancement-Mode Silicon Gate



ON Semiconductor®

<http://onsemi.com>

This advanced high voltage TMOS E-FET is designed to withstand high energy in the avalanche mode and switch efficiently. This new high energy device also offers a drain-to-source diode with fast recovery time. Designed for high voltage, high speed switching applications such as power supplies, PWM motor controls and other inductive loads, the avalanche energy capability is specified to eliminate the guesswork in designs where inductive loads are switched and offer additional safety margin against unexpected voltage transients.

- Avalanche Energy Capability Specified at Elevated Temperature
- Low Stored Gate Charge for Efficient Switching
- Internal Source-to-Drain Diode Designed to Replace External Zener Transient Suppressor — Absorbs High Energy in the Avalanche Mode
- Source-to-Drain Diode Recovery Time Comparable to Discrete Fast Recovery Diode

TMOS POWER FET
3.0 AMPERES, 500 VOLTS

$$R_{DS(on)} = 3.0 \Omega$$

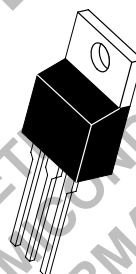

TO-220AB
CASE 221A-06
Style 5

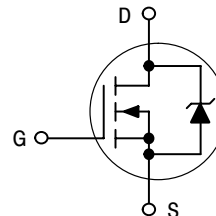

MTP3N50E

MAXIMUM RATINGS (T_C = 25°C unless otherwise noted)

Rating	Symbol	Value	Unit
Drain-Source Voltage	V _{DSS}	500	Vdc
Drain-Gate Voltage (R _{GS} = 1.0 MΩ)	V _{DGR}	500	Vdc
Gate-Source Voltage — Continuous — Non-repetitive (t _p ≤ 50 μs)	V _{GS} V _{GSM}	±20 ±40	Vdc Vpk
Drain Current — Continuous — Pulsed	I _D I _{DM}	3.0 10	Adc
Total Power Dissipation @ T _C = 25°C Derate above 25°C	P _D	50 0.4	Watts W/°C
Operating and Storage Temperature Range	T _J , T _{stg}	-65 to 150	°C

UNCLAMPED DRAIN-TO-SOURCE AVALANCHE CHARACTERISTICS (T_J < 150°C)

Single Pulse Drain-to-Source Avalanche Energy — T _J = 25°C — T _J = 100°C	W _{DSR} (1)	210 33	mJ
Repetitive Pulse Drain-to-Source Avalanche Energy	W _{DSR} (2)	5.0	

THERMAL CHARACTERISTICS

Thermal Resistance — Junction to Case — Junction to Ambient	R _{θJC} R _{θJA}	2.5 62.5	°C/W
Maximum Lead Temperature for Soldering Purposes, 1/8" from case for 10 seconds	T _L	260	°C

(1) V_{DD} = 50 V, I_D = 3.0 A

(2) Pulse Width and frequency is limited by T_J(max) and thermal response

Designer's Data for "Worst Case" Conditions — The Designer's Data Sheet permits the design of most circuits entirely from the information presented. SOA Limit curves — representing boundaries on device characteristics — are given to facilitate "worst case" design.

Preferred devices are Motorola recommended choices for future use and best overall value.

MTP3N50E

ELECTRICAL CHARACTERISTICS (T_J = 25°C unless otherwise noted)

Characteristic	Symbol	Min	Typ	Max	Unit
----------------	--------	-----	-----	-----	------

OFF CHARACTERISTICS

Drain-to-Source Breakdown Voltage (V _{GS} = 0, I _D = 0.25 mA)	V _{(BR)DSS}	500	—	—	Vdc
Zero Gate Voltage Drain Current (V _{DS} = 500 V, V _{GS} = 0) (V _{DS} = 400 V, V _{GS} = 0, T _J = 125°C)	I _{DSS}	—	—	0.25 1.0	mAdc
Gate-Body Leakage Current, Forward (V _{GSF} = 20 Vdc, V _{DS} = 0)	I _{GSSF}	—	—	100	nAdc
Gate-Body Leakage Current, Reverse (V _{GSR} = 20 Vdc, V _{DS} = 0)	I _{GSSR}	—	—	100	nAdc

ON CHARACTERISTICS*

Gate Threshold Voltage (V _{DS} = V _{GS} , I _D = 0.25 mAdc) (T _J = 125°C)	V _{GS(th)}	2.0 1.5	—	4.0 3.5	Vdc
Static Drain-Source On-Resistance (V _{GS} = 10 Vdc, I _D = 1.5 Adc)	R _{DS(on)}	—	2.4	3.0	Ohm
Drain-Source On-Voltage (V _{GS} = 10 Vdc) (I _D = 3.0 A) (I _D = 1.5 A, T _J = 100°C)	V _{DS(on)}	—	—	10 8.0	Vdc
Forward Transconductance (V _{DS} = 15 Vdc, I _D = 1.5 Adc)	g _{FS}	1.0	—	—	mhos

DYNAMIC CHARACTERISTICS

Input Capacitance	(V _{DS} = 25 V, V _{GS} = 0, f = 1.0 MHz)	C _{iss}	—	435	—	pF
Output Capacitance		C _{oss}	—	56	—	
Transfer Capacitance		C _{rss}	—	9.2	—	

SWITCHING CHARACTERISTICS*

Turn-On Delay Time	(V _{DD} = 250 V, I _D ≈ 3.0 A, R _G = 18 Ω, R _L = 83 Ω, V _{GS(on)} = 10 V)	t _{d(on)}	—	14	—	ns
Rise Time		t _r	—	14	—	
Turn-Off Delay Time		t _{d(off)}	—	30	—	
Fall Time		t _f	—	20	—	
Total Gate Charge	(V _{DS} = 400 V, I _D = 3.0 A, V _{GS} = 10 V)	Q _g	—	15	21	nC
Gate-Source Charge		Q _{gs}	—	2.5	—	
Gate-Drain Charge		Q _{gd}	—	10	—	

SOURCE-DRAIN DIODE CHARACTERISTICS*

Forward On-Voltage	(I _S = 3.0 A)	V _{SD}	—	—	1.5	Vdc
Forward Turn-On Time	(I _S = 3.0 A, di/dt = 100 A/μs)	t _{on}	—	**	—	ns
Reverse Recovery Time		t _{rr}	—	200	—	

INTERNAL PACKAGE INDUCTANCE

Internal Drain Inductance (Measured from the contact screw on tab to center of die) (Measured from the drain lead 0.25" from package to center of die)	L _d	—	—	3.5 4.5	—	nH
Internal Source Inductance (Measured from the source lead 0.25" from package to source bond pad)	L _s	—	—	7.5	—	

* Indicates Pulse Test: Pulse Width = 300 μs Max, Duty Cycle ≤ 2.0%.

** Limited by circuit inductance.

MTP3N50E

TYPICAL ELECTRICAL CHARACTERISTICS

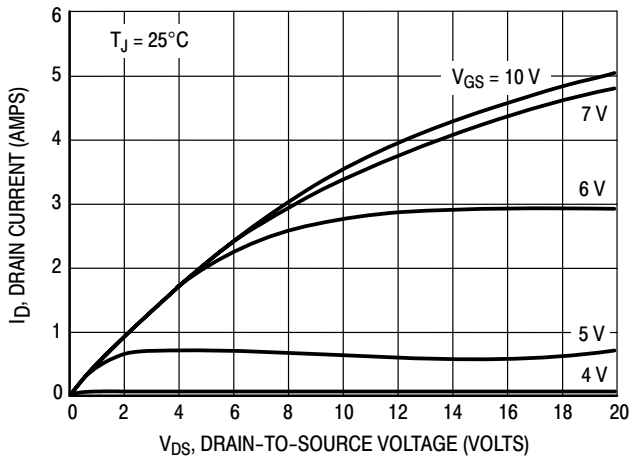

Figure 1. On-Region Characteristics

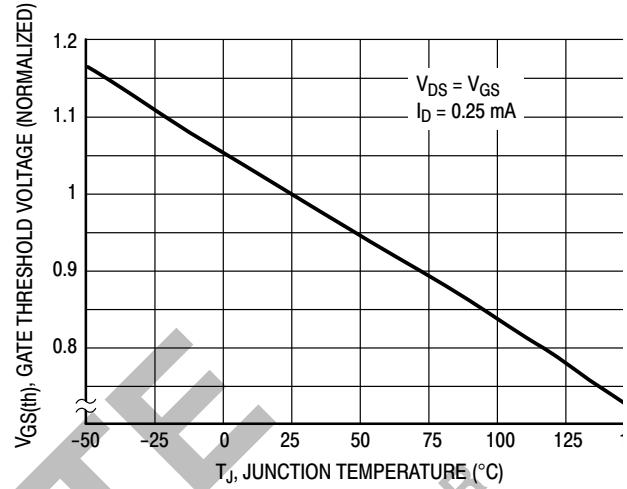

Figure 2. Gate-Threshold Voltage Variation With Temperature

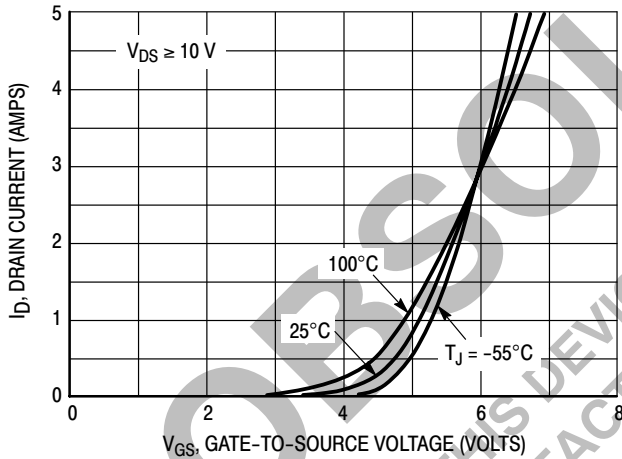

Figure 3. Transfer Characteristics

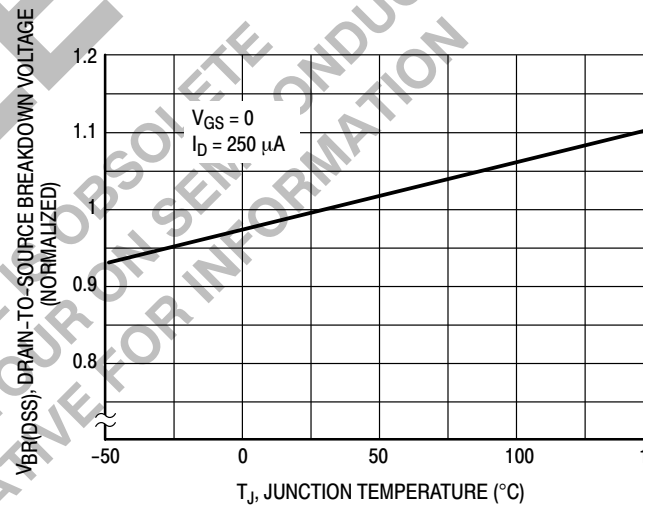

Figure 4. Breakdown Voltage Variation With Temperature

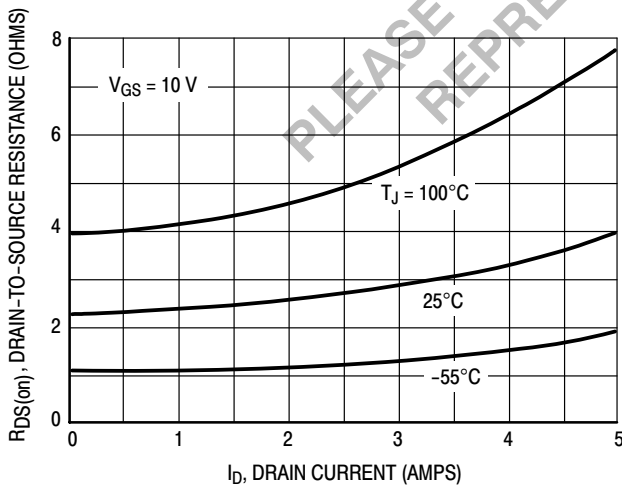

Figure 5. On-Resistance versus Drain Current

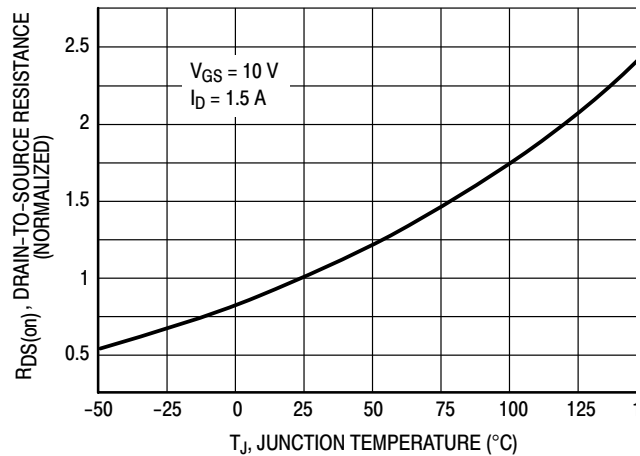

Figure 6. On-Resistance versus Temperature

SAFE OPERATING AREA INFORMATION

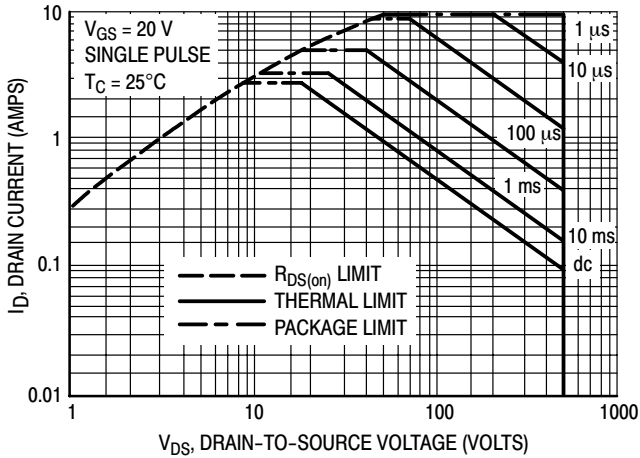

Figure 7. Maximum Rated Forward Biased Safe Operating Area

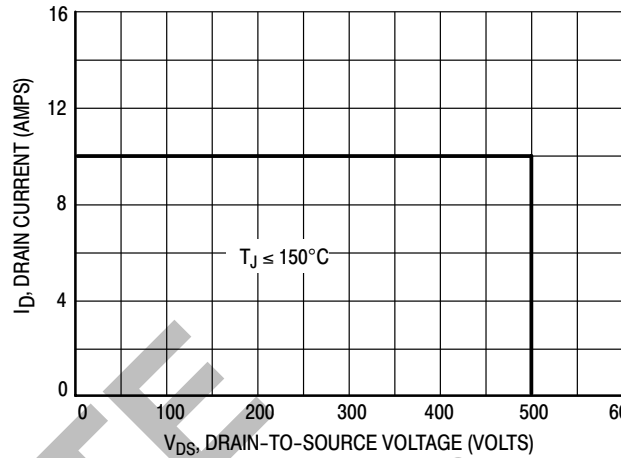

Figure 8. Maximum Rated Switching Safe Operating Area

FORWARD BIASED SAFE OPERATING AREA

The FBSOA curves define the maximum drain-to-source voltage and drain current that a device can safely handle when it is forward biased, or when it is on, or being turned on. Because these curves include the limitations of simultaneous high voltage and high current, up to the rating of the device, they are especially useful to designers of linear systems. The curves are based on a case temperature of 25°C and a maximum junction temperature of 150°C. Limitations for repetitive pulses at various case temperatures can be determined by using the thermal response curves. Motorola Application Note, AN569, "Transient Thermal Resistance—General Data and Its Use" provides detailed instructions.

SWITCHING SAFE OPERATING AREA

The switching safe operating area (SOA) of Figure 8 is the boundary that the load line may traverse without incurring damage to the MOSFET. The fundamental limits are the peak current, I_{DM} and the breakdown voltage, $V_{(BR)DSS}$. The switching SOA shown in Figure 8 is

applicable for both turn-on and turn-off of the devices for switching times less than one microsecond.

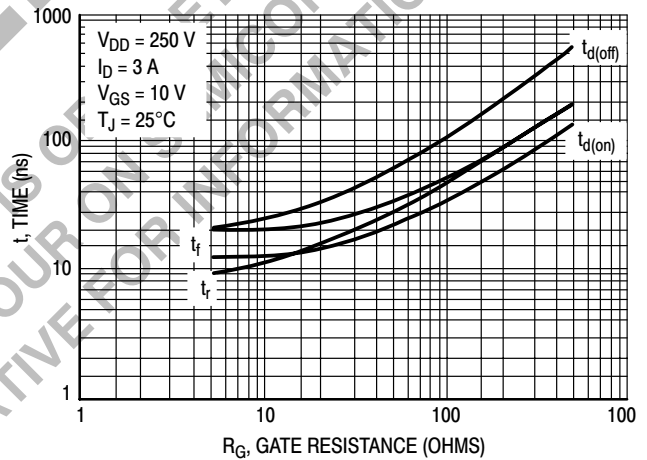

Figure 9. Resistive Switching Time Variation versus Gate Resistance

MTP3N50E

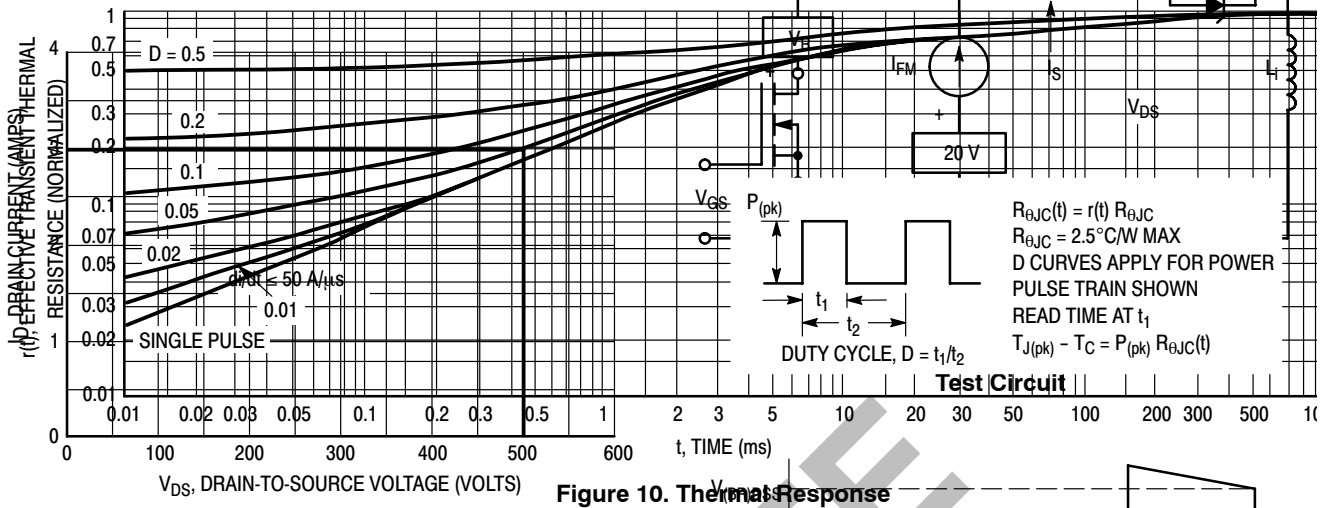

Figure 10. Thermal Response

Figure 12. Commutating Safe Operating Area (CSOA)

COMMUTATING SAFE OPERATING AREA (CSOA)

The Commutating Safe Operating Area (CSOA) of Figure 12 defines the limits of safe operation for commutated source-drain current versus re-applied drain voltage when the source-drain diode has undergone forward bias. The curve shows the limitations of I_{FM} and peak V_R for a given commutation speed. It is applicable when waveforms similar to those of Figure 11 are present. Full or half-bridge PWM DC motor controllers are common applications requiring CSOA data.

The time interval t_{rr} is the speed of the commutation cycle. Device stresses increase with commutation speed, so t_{rr} is specified with a minimum value. Faster commutation speeds require an appropriate derating of I_{FM} , peak V_R or both. Ultimately, t_{rr} is limited primarily by device, package, and circuit impedances. Maximum device stress occurs during t_{rr} as the diode goes from conduction to reverse blocking.

$V_{DS(pk)}$ is the peak drain-to-source voltage that the device must sustain during commutation; I_{FM} is the maximum forward source-drain diode current just prior to the onset of commutation.

V_R is specified at 80% of $V_{(BR)DSS}$ to ensure that the CSOA stress is maximized as I_S decays from I_{RM} to zero.

R_{GS} should be minimized during commutation. T_J has only a second order effect on CSOA.

Stray inductances, L_i in Motorola's test circuit are assumed to be practical minimums.

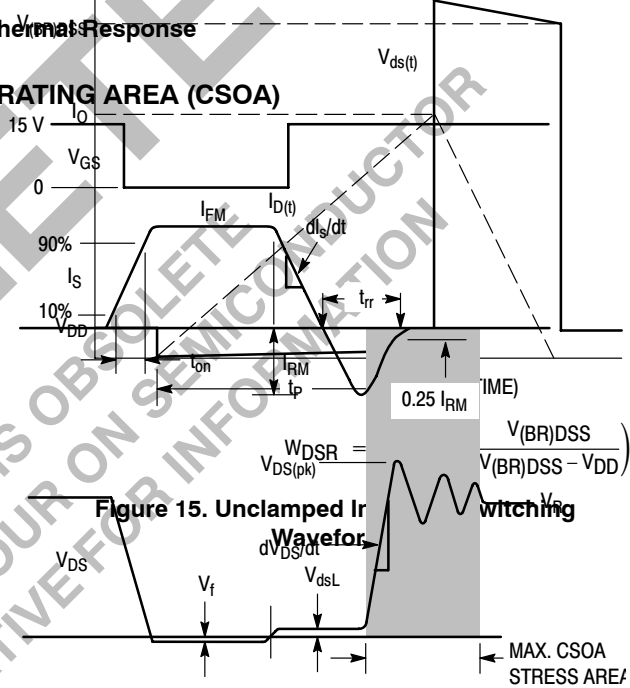
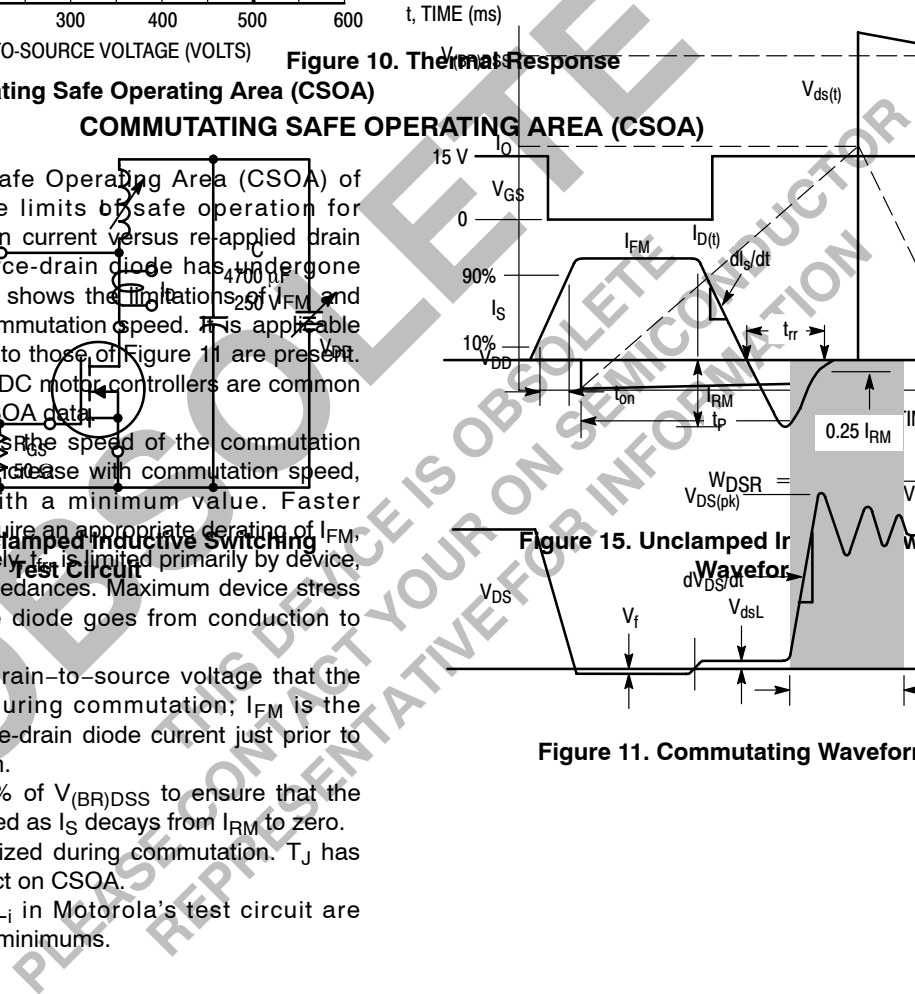

Figure 11. Commutating Waveforms

Figure 15. Unclamped I_r Waveform



MTP3N50E

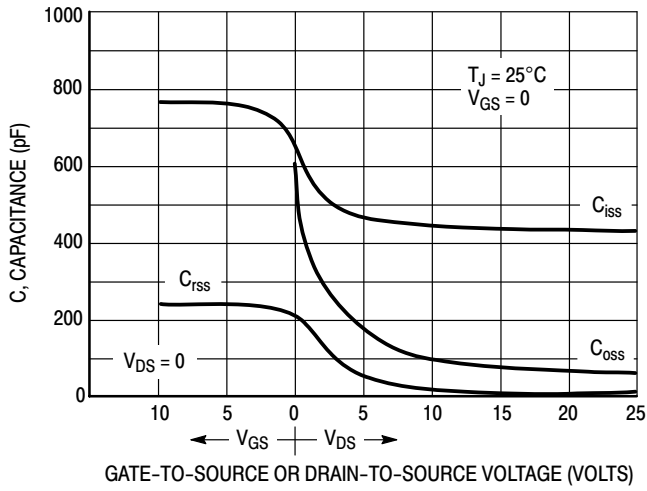

Figure 16. Capacitance Variation

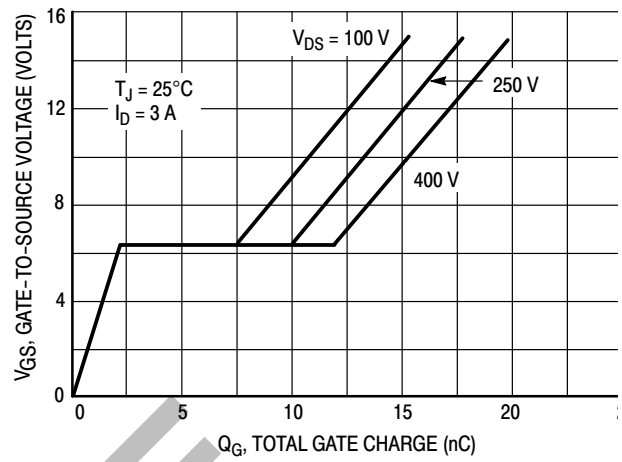

Figure 17. Gate Charge versus Gate-To-Source Voltage

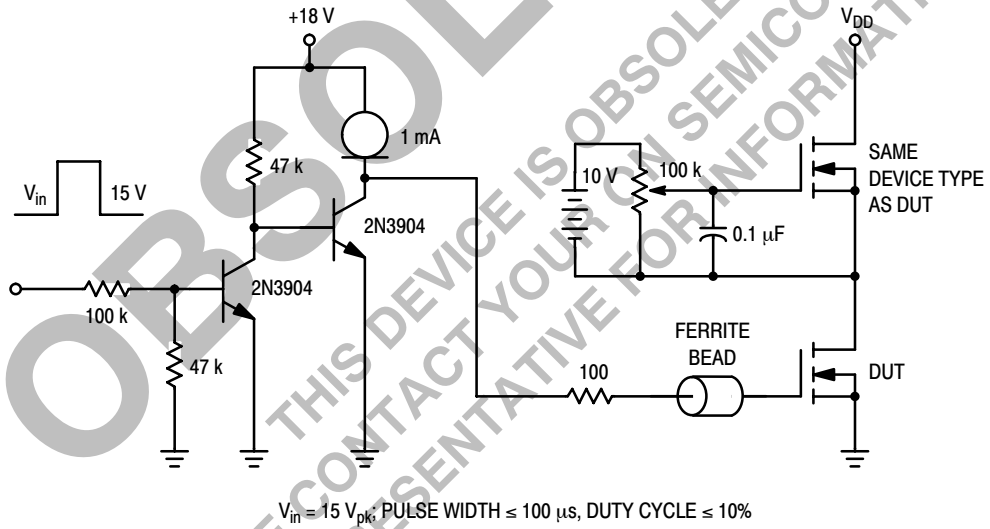
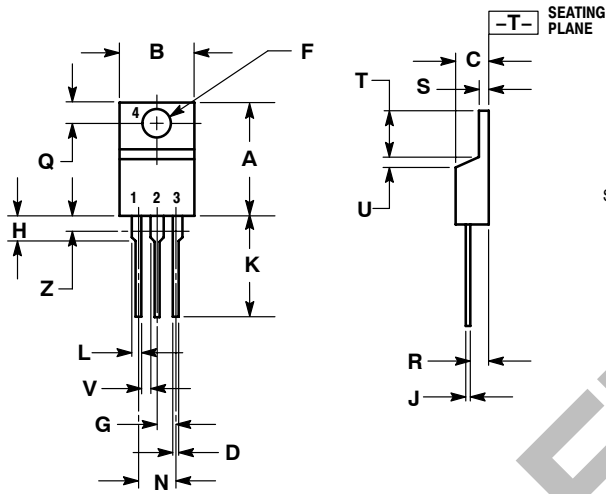

Figure 18. Gate Charge Test Circuit

MTP3N50E

PACKAGE DIMENSIONS

CASE 221A-06 ISSUE Y



STYLE 5:
PIN 1. GATE
2. DRAIN
3. SOURCE
4. DRAIN

NOTES:

1. DIMENSIONING AND TOLERANCING PER ANSI Y14.5M, 1982.
2. CONTROLLING DIMENSION: INCH.
3. DIMENSION Z DEFINES A ZONE WHERE ALL BODY AND LEAD IRREGULARITIES ARE ALLOWED.

DIM	INCHES		MILLIMETERS	
	MIN	MAX	MIN	MAX
A	0.570	0.620	14.48	15.75
B	0.380	0.405	9.66	10.28
C	0.160	0.190	4.07	4.82
D	0.025	0.035	0.64	0.88
F	0.142	0.147	3.61	3.73
G	0.095	0.105	2.42	2.66
H	0.110	0.155	2.80	3.93
J	0.018	0.025	0.46	0.64
K	0.500	0.562	12.70	14.27
L	0.045	0.060	1.15	1.52
N	0.190	0.210	4.83	5.33
Q	0.100	0.120	2.54	3.04
R	0.080	0.110	2.04	2.79
S	0.045	0.055	1.15	1.39
T	0.235	0.255	5.97	6.47
U	0.000	0.050	0.00	1.27
V	0.045	---	1.15	---
Z	---	0.080	---	2.04

OBSOLETE

THIS DEVICE IS OBSOLETE
PLEASE CONTACT YOUR ON SEMICONDUCTOR
REPRESENTATIVE FOR INFORMATION

E-FET and Designer's are trademarks of Motorola, Inc. TMOS is a registered trademark of Motorola, Inc.

ON Semiconductor and are registered trademarks of Semiconductor Components Industries, LLC (SCILLC). SCILLC reserves the right to make changes without further notice to any products herein. SCILLC makes no warranty, representation or guarantee regarding the suitability of its products for any particular purpose, nor does SCILLC assume any liability arising out of the application or use of any product or circuit, and specifically disclaims any and all liability, including without limitation special, consequential or incidental damages. "Typical" parameters which may be provided in SCILLC data sheets and/or specifications can and do vary in different applications and actual performance may vary over time. All operating parameters, including "Typicals" must be validated for each customer application by customer's technical experts. SCILLC does not convey any license under its patent rights nor the rights of others. SCILLC products are not designed, intended, or authorized for use as components in systems intended for surgical implant into the body, or other applications intended to support or sustain life, or for any other application in which the failure of the SCILLC product could create a situation where personal injury or death may occur. Should Buyer purchase or use SCILLC products for any such unintended or unauthorized application, Buyer shall indemnify and hold SCILLC and its officers, employees, subsidiaries, affiliates, and distributors harmless against all claims, costs, damages, and expenses, and reasonable attorney fees arising out of, directly or indirectly, any claim of personal injury or death associated with such unintended or unauthorized use, even if such claim alleges that SCILLC was negligent regarding the design or manufacture of the part. SCILLC is an Equal Opportunity/Affirmative Action Employer. This literature is subject to all applicable copyright laws and is not for resale in any manner.

PUBLICATION ORDERING INFORMATION

LITERATURE FULFILLMENT:
Literature Distribution Center for ON Semiconductor
P.O. Box 5163, Denver, Colorado 80217 USA
Phone: 303-675-2175 or 800-344-3860 Toll Free USA/Canada
Fax: 303-675-2176 or 800-344-3867 Toll Free USA/Canada
Email: orderlit@onsemi.com

N. American Technical Support: 800-282-9855 Toll Free
USA/Canada
Europe, Middle East and Africa Technical Support:
Phone: 421 33 790 2910
Japan Customer Focus Center
Phone: 81-3-5773-3850

ON Semiconductor Website: www.onsemi.com
Order Literature: <http://www.onsemi.com/orderlit>
For additional information, please contact your local Sales Representative