

FEATURES

- Low drain-source ON resistance
- High forward transfer admittance
- Repetitive avalanche ratings
- Simple drive requirements
- Ease of paralleling

APPLICATIONS

- Switching power supplies
- Motor controls
- Inverters and choppers
- Audio amplifiers and energy pulse circuits

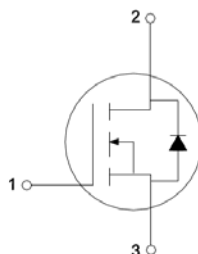

1.GATE
2.DRAIN
3.SOURCE

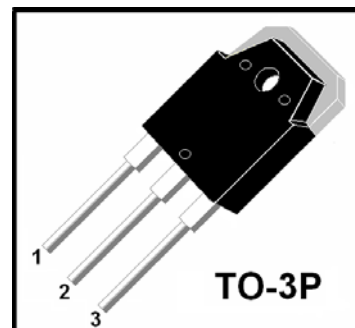

ABSOLUTE MAXIMUM RATINGS

$T_C=25^{\circ}\text{C}$ unless otherwise specified

Symbol	Parameter	Test Conditions	Values	Unit
V_{DS}	Drain - Source Voltage	$T_J=25^{\circ}\text{C}$	500	V
V_{GS}	Gate - Source Voltage		± 20	V
I_D	Continuous Drain Current	$T_C=25^{\circ}\text{C}$	22	A
		$T_C=100^{\circ}\text{C}$	15	A
I_{DM}	Pulsed Drain Current	Limited by T_{jmax}	60	A
P_D	Maximum Power Dissipation		150	W
E_{AS}	Single Pulse Avalanche Energy		800	mJ
I_{AR}	Avalanche Current		22	A
E_{AR}	Repetitive Avalanche Energy		25	mJ
T_J	Operating Junction		150	$^{\circ}\text{C}$
T_{STG}	Storage Temperature Range		-55~150	$^{\circ}\text{C}$
Weight			12	g

THERMAL CHARACTERISTICS

$T_C=25^{\circ}\text{C}$ unless otherwise specified

Symbol	Parameter	Test Conditions	Values	Unit
$R_{th(ch-c)}$	Thermal resistance,channel to case		0.83	$^{\circ}\text{C}/\text{W}$
$R_{th(ch-a)}$	Thermal resistance,channel to ambient		40	$^{\circ}\text{C}/\text{W}$

MM15N050P

ELECTRICAL CHARACTERISTICS

$T_C=25^\circ\text{C}$ unless otherwise specified

Symbol	Parameter	Test Conditions	Min.	Typ.	Max.	Unit
$V_{(BR)DSS}$	Drain-Source Breakdown Voltage	$V_{GS}=0V, I_D=250\mu A$	500			V
$R_{DS(ON)}$	Drain-Source ON Resistance	$V_{GS}=10V, I_D=7A$		0.27		Ω
		$V_{GS}=10V, I_D=15A$		0.28		Ω
$V_{GS(th)}$	Gate Threshold Voltage	$V_{GS}=V_{DS}, I_D=250\mu A$	2	3	4	V
I_{GSS}	Gate Leakage Current	$V_{DS}=0V, V_{GS}=\pm 20V$	-200		200	nA
I_{DSS}	Zero Gate Voltage Drain Current	$V_{DS}=500V, V_{GS}=0V$			100	μA
Q_g	Total Gate Charge	$V_{DD}=300V, I_D=15A, V_{GS}=10V$		99		nC
Q_{gs}	Gate-Source Charge			35		nC
Q_{gd}	Gate-Drain Charge			32		nC
g_{fs}	Forward Transconductance	$V_{DS}=50V, I_D=7A$		12		S
C_{iss}	Input Capacitance	$V_{DS}=25V, V_{GS}=0V, f=1\text{MHz}$		4400		pF
C_{oss}	Output Capacitance			900		pF
C_{rss}	Reverse Transfer Capacitance			270		pF
$t_{d(on)}$	Turn - on Delay Time	$V_{DD}=300V, I_D=15A,$ $R_G=7.5\Omega,$ $V_{GS}=10V,$ $R_L=20\Omega$	$T_J=25^\circ\text{C}$	30		ns
			$T_J=125^\circ\text{C}$	32		ns
t_r	Rise Time		$T_J=25^\circ\text{C}$	35		ns
			$T_J=125^\circ\text{C}$	38		ns
$t_{d(off)}$	Turn - off Delay Time		$T_J=25^\circ\text{C}$	100		ns
			$T_J=125^\circ\text{C}$	105		ns
t_f	Fall Time		$T_J=25^\circ\text{C}$	28		ns
			$T_J=125^\circ\text{C}$	35		ns

Source-Drain RATINGS AND CHARACTERISTICS

$T_C=25^\circ\text{C}$ unless otherwise specified

Symbol	Parameter	Test Conditions	Min.	Typ.	Max.	Unit
I_{SD}	Continuous Source-Drain Current				15	A
I_{SDM}	Pulse Source-Drain Current				60	A
V_{SD}	Source-Drain Voltage	$I_{SD}=15A, V_{GS}=0V, T_J=25^\circ\text{C}$		0.85	1.6	V
t_{rr}	Reverse Recovery Time	$I_{SD}=15A, di_{SD}/dt=-100A/\mu s$ $T_J=25^\circ\text{C}$		420		ns
I_{RRM}	Max. Reverse Recovery Current			18		A
Q_{RRM}	Max. Reverse Recovery Charge			4.3		μC

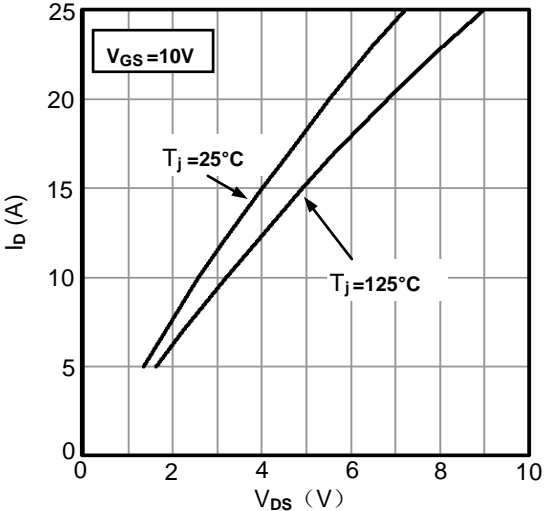

Figure1. Typical Output Characteristics

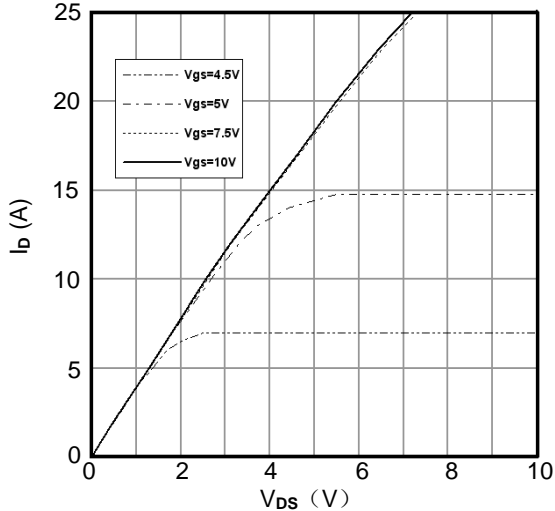

Figure2. Typical Output Characteristics

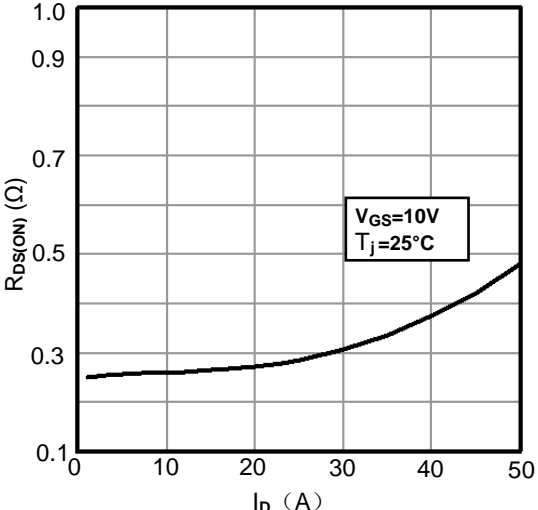

Figure3. Drain-Source ON Resistance vs. I_D

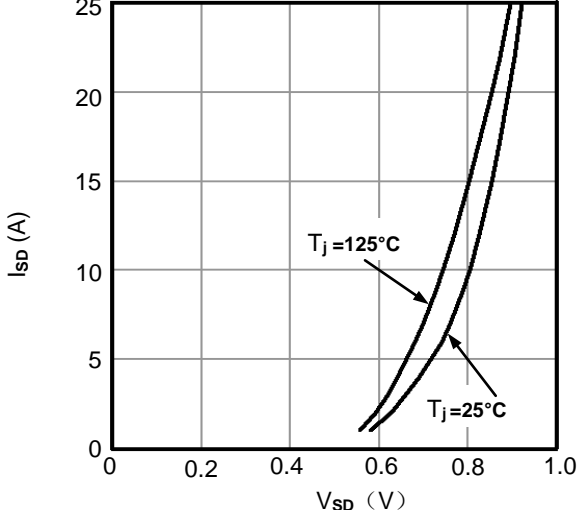

Figure4. Source-Drain Voltage

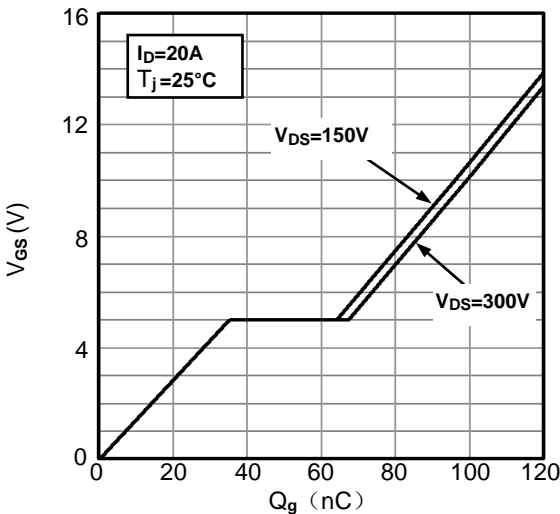

Figure5. Gate Charge characteristics

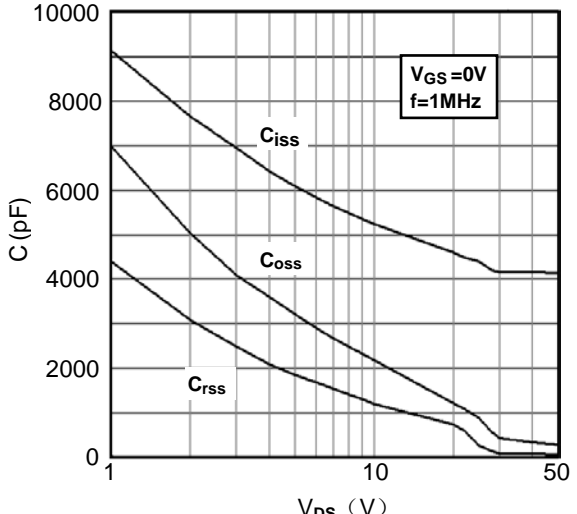

Figure6. Typical Capacitances vs. V_DS

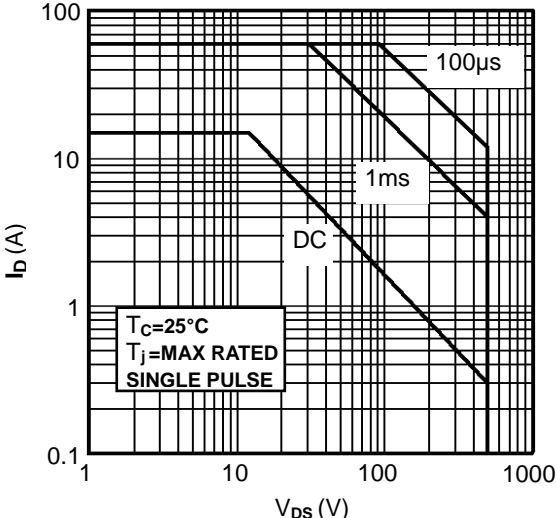

Figure 7. Forward Bias Safe Operating Area

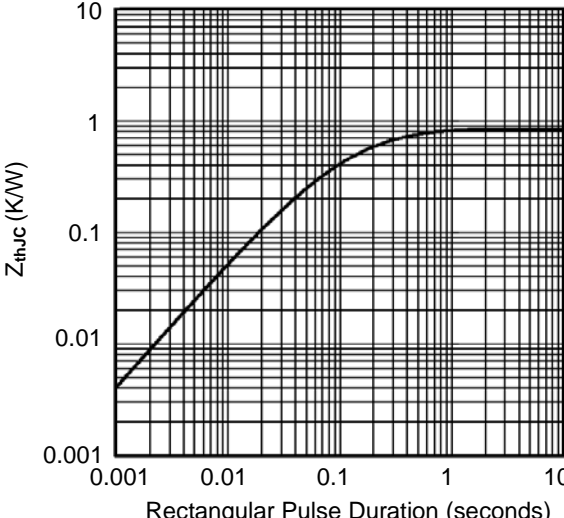

Figure 8. Transient Thermal Impedance

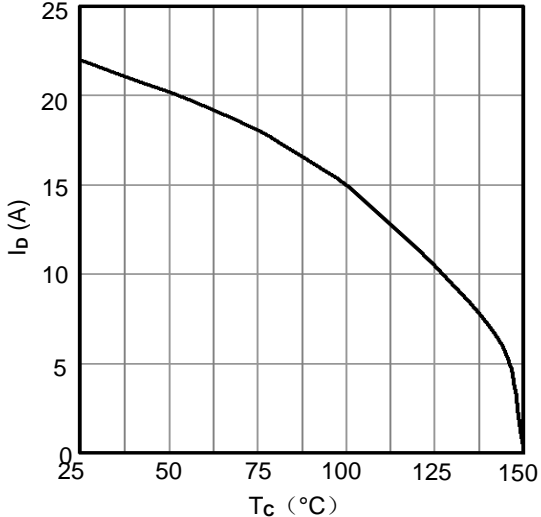

Figure 9. Maximum Continuous Drain Current vs. Case Temperature

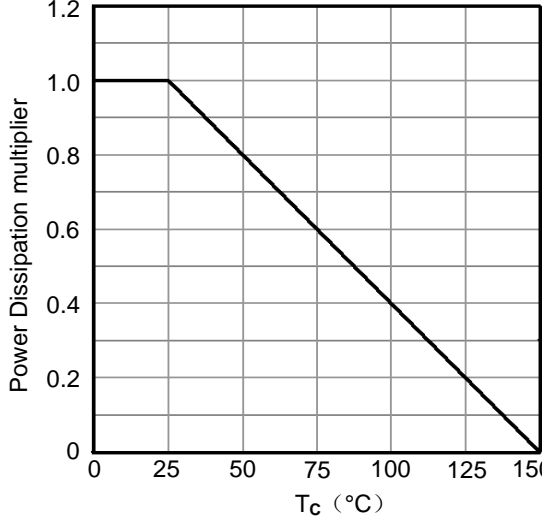

Figure 10. Normalized Power Dissipation vs. Case Temperature

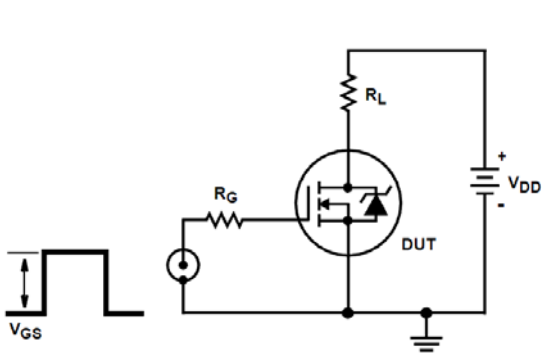

Figure 11. Switching Time Test Circuit

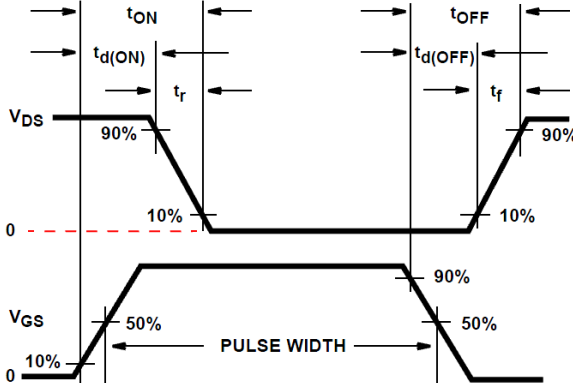

Figure 12. Resistive Switching Waveforms

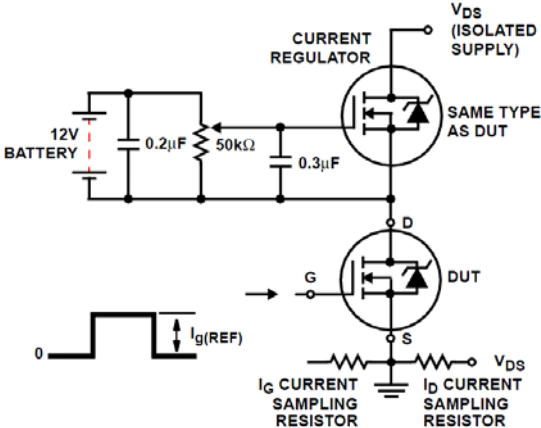

Figure13. Gate Charge Test Circuit

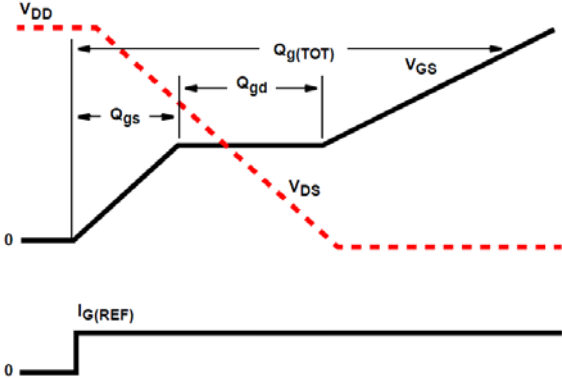
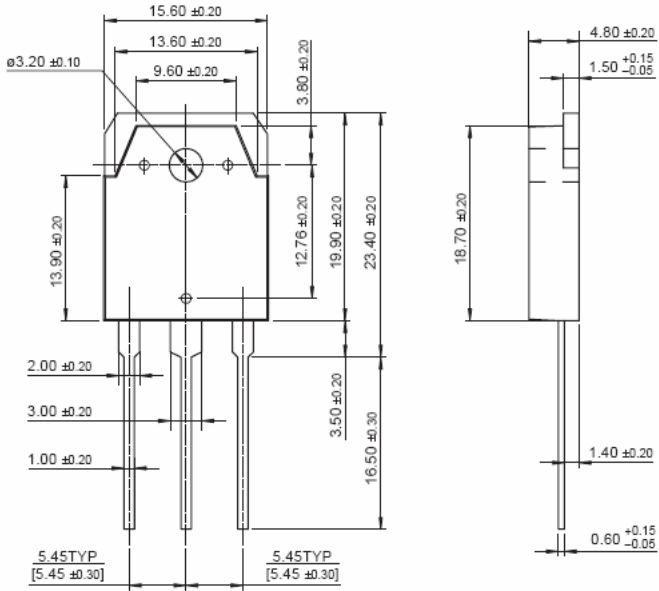

Figure14. Gate Charge Waveforms



Dimensions (mm)
Figure15. Package Outline