



CHENMKO ENTERPRISE CO.,LTD

SURFACE MOUNT

Dual N-Channel Enhancement MOS FET

VOLTAGE 60 Volts CURRENT 0.280 Ampere

2N7002VGP

Halogens free devices

APPLICATION

- * Servo motor control.
- * Power MOSFET gate drivers.
- * Other switching applications.

FEATURE

- * Small surface mounting type. (SOT-563)
- * High density cell design for low $R_{DS(ON)}$
- * Suitable for high packing density.
- * Rugged and reliable.
- * High saturation current capability.
- * Voltage controlled small signal switch.

CONSTRUCTION

- * Dual N-Channel Enhancement

MARKING

- * V7



SOT-563

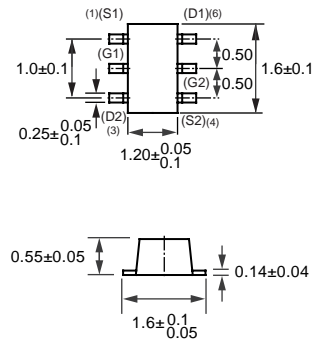

Dimensions in millimeters

SOT-563

CIRCUIT

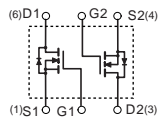

Absolute Maximum Ratings $T_A = 25^\circ\text{C}$ unless otherwise noted

Symbol	Parameter	2N7002VGP	Units
V_{DSS}	Drain-Source Voltage	60	V
V_{DGR}	Drain-Gate Voltage ($R_{GS} \leq 1 \text{ M}\Omega$)	60	V
V_{ESS}	Gate-Source Voltage - Continuous	± 20	V
	- Non Repetitive ($t_p < 50\mu\text{s}$)	± 40	
I_D	Maximum Drain Current - Continuous	280	mA
P_D	Maximum Power Dissipation	250	mW
T_J, T_{STG}	Operating and Storage Temperature Range	-55 to 150	$^\circ\text{C}$
T_L	Maximum Lead Temperature for Soldering Purposes, 1/16" from Case for 10 Seconds	300	$^\circ\text{C}$

Thermal characteristics

$R_{\theta JA}$	Thermal Resistance, Junction-to-Ambient	833	$^\circ\text{C/W}$
-----------------	---	-----	--------------------

2004-06

RATING CHARACTERISTIC CURVES (2N7002VGP)

Electrical Characteristics $T_A = 25^\circ\text{C}$ unless otherwise noted

Symbol	Parameter	Conditions	Min	Typ	Max	Units
--------	-----------	------------	-----	-----	-----	-------

OFF CHARACTERISTICS

BV_{DSS}	Drain-Source Breakdown Voltage	$V_{GS} = 0\text{ V}, I_D = 10\ \mu\text{A}$	60	70		V
I_{DSS}	Zero Gate Voltage Drain Current	$V_{DS} = 60\text{ V}, V_{GS} = 0\text{ V}$			1	μA
		$T_C = 125^\circ\text{C}$			500	μA
I_{GSSF}	Gate - Body Leakage, Forward	$V_{GS} = 20\text{ V}, V_{DS} = 0\text{ V}$			100	nA
I_{GSSR}	Gate - Body Leakage, Reverse	$V_{GS} = -20\text{ V}, V_{DS} = 0\text{ V}$			-100	nA

ON CHARACTERISTICS (Note 1)

$V_{GS(th)}$	Gate Threshold Voltage	$V_{DS} = V_{GS}, I_D = 250\ \mu\text{A}$	1		2.5	V
$R_{DS(on)}$	Static Drain-Source On-Resistance	$V_{GS} = 10\text{ V}, I_D = 500\text{ mA}, T_j = 125^\circ\text{C}$			13.5	Ω
		$V_{GS} = 5.0\text{ V}, I_D = 50\text{ mA}$			7.5	
$I_{D(on)}$	On-State Drain Current	$V_{GS} = 10\text{ V}, V_{DS} = 7.5V_{DS(on)}$	800	1000		mA
g_{FS}	Forward Transconductance	$V_{DS} = 10\text{ V}, I_D = 200\text{ mA}$		200		mS

DYNAMIC CHARACTERISTICS

C_{iss}	Input Capacitance	$V_{DS} = 25\text{ V}, V_{GS} = 0\text{ V},$ $f = 1.0\text{ MHz}$			50	pF
C_{oss}	Output Capacitance				25	
C_{rss}	Reverse Transfer Capacitance				5	
t_{on}	Turn-On Time	$V_{DD} = 30\text{ V}, R_L = 150\ \Omega,$ $I_D = 200\text{ mA}, V_{GS} = 10\text{ V},$ $R_{GEN} = 25\ \Omega$			20	nS
t_{off}	Turn-Off Time				20	

Note:

1. Pulse Test: Pulse Width < 300 μs , Duty Cycle < 2.0%.

RATING CHARACTERISTIC CURVES (2N7002VGP)

Typical Electrical Characteristics

Figure 1. On-Region Characteristics

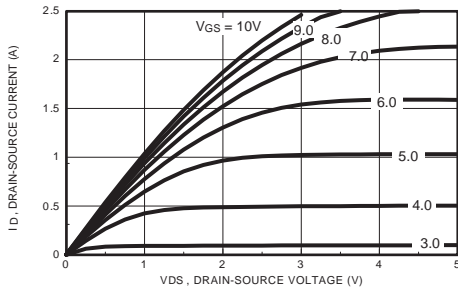

Figure 2. On-Resistance Variation with Gate Voltage and Drain Current

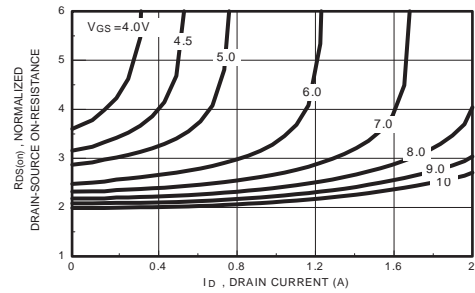

Figure 3. On-Resistance Variation with Temperature

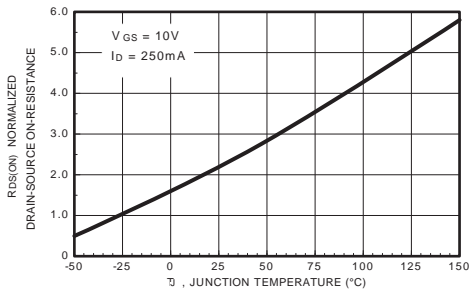

Figure 4. On-Resistance Variation with Drain Current and Temperature

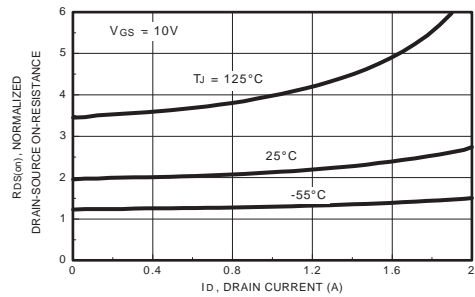

Figure 5. Transfer Characteristics

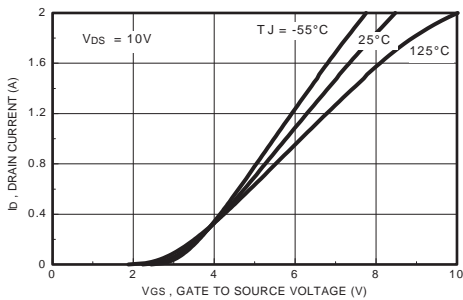
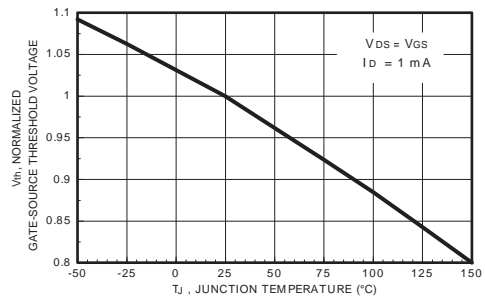

Figure 6. Gate Threshold Variation with Temperature



RATING CHARACTERISTIC CURVES (2N7002VGP)

Typical Electrical Characteristics (continued)

Figure 7. Breakdown Voltage Variation with Temperature

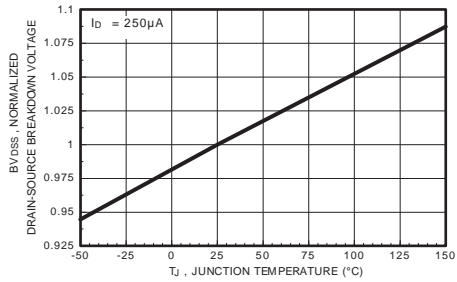

Figure 8. Body Diode Forward Voltage Variation with Drain Current

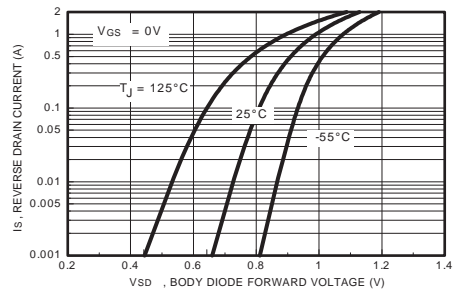

Figure 9. Capacitance Characteristics

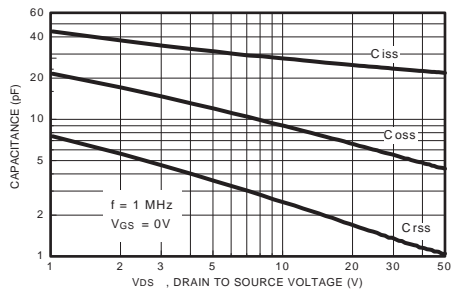

Figure 10. Gate Charge Characteristics

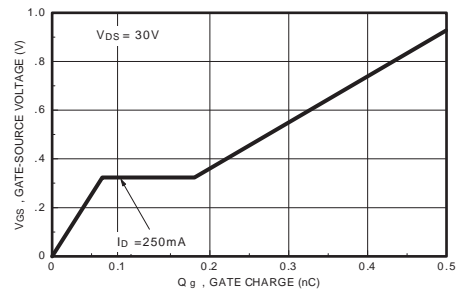

Figure 11.

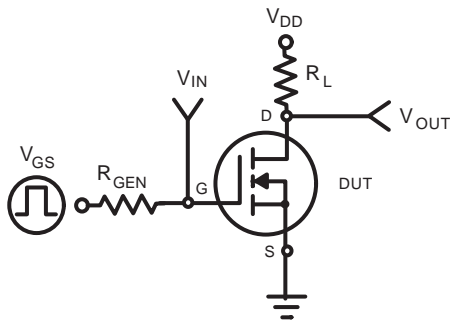
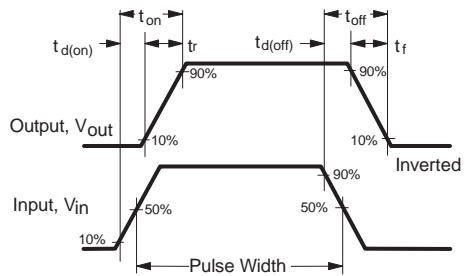

Figure 12. Switching Waveforms



RATING CHARACTERISTIC CURVES (2N7002VGP)

Typical Electrical Characteristics (continued)

Figure 13. 2N7002VGP Maximum Safe Operating Area

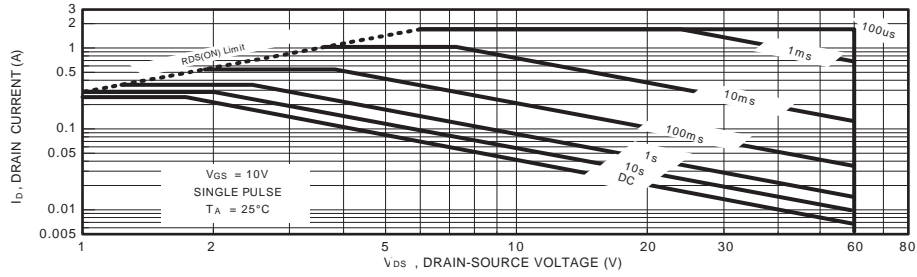

Figure 14. 2N7002VGP Transient Thermal Response Curve

