



CHENMKO ENTERPRISE CO.,LTD

Halogens free devices

**SURFACE MOUNT
SWITCHING DIODE**

VOLTAGE 80 Volts CURRENT 25 mAmpere

CHN1GP

APPLICATION

* Ultra high speed switching

FEATURE

- * Small surface mounting type. (SC-74A)
- * Multiple diodes in one small surface mount package.
- * Suitable for high packing density.
- * Maximum total power dissipation is 150mW.
- * Peak forward current is 80mA.

CONSTRUCTION

* Silicon epitaxial planar

MARKING

* D1

CIRCUIT

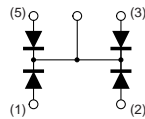

SC-74A

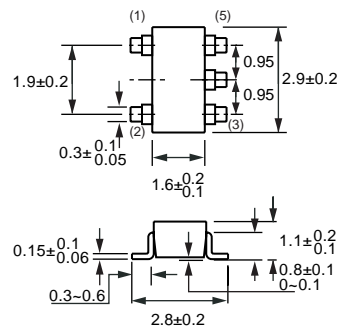

Dimensions in millimeters

SC-74A

MAXIMUM RATINGS (At TA = 25°C unless otherwise noted)

RATINGS	SYMBOL	CHN1GP	UNITS
Maximum Recurrent Peak Reverse Voltage	VRRM	80	Volts
Maximum RMS Voltage	VRMS	56	Volts
Maximum DC Blocking Voltage	VDC	80	Volts
Maximum Average Forward Rectified Current	Io	25	mAmps
Peak Forward Surge Current at 1uSec.	IFSM	0.25	Amps
Typical Junction Capacitance between Terminal (Note 1)	CJ	3.5	pF
Maximum Reverse Recovery Time (Note 2)	TRR	4.0	nSec
Maximum Operating Temperature Range	TJ	+150	°C
Storage Temperature Range	TSTG	-55 to +150	°C

ELECTRICAL CHARACTERISTICS (At TA = 25°C unless otherwise noted)

CHARACTERISTICS	SYMBOL	CHN1GP	UNITS
Maximum Instantaneous Forward Voltage at If= 5mA	VF	0.90	Volts
Maximum Average Reverse Current at VR= 70V	IR	0.1	uAmps

- NOTES : 1. Measured at 1.0 MHz and applied reverse voltage of 6.0 volts.
 2. Measured at applied forward current of 5mA and reverse voltage of 6.0 volts.
 3. ESD sensitive product handling required.

RATING CHARACTERISTIC CURVES (CHN1GP)

FIG. 1 - POWER DERATING CURVE

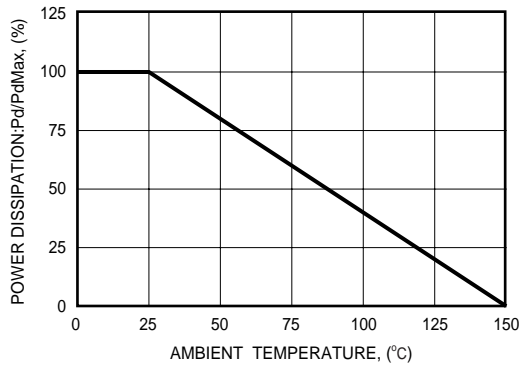

FIG. 2 - FORWARD CHARACTERISTICS

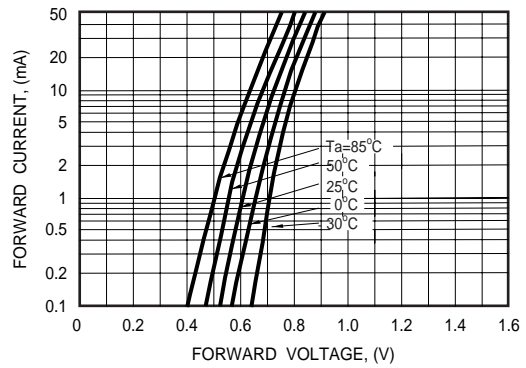

FIG. 3 - TYPICAL JUNCTION CAPACITANCE

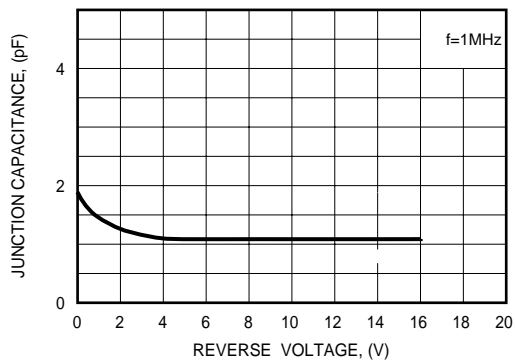

FIG. 4 - REVERSE CHARACTERISTICS

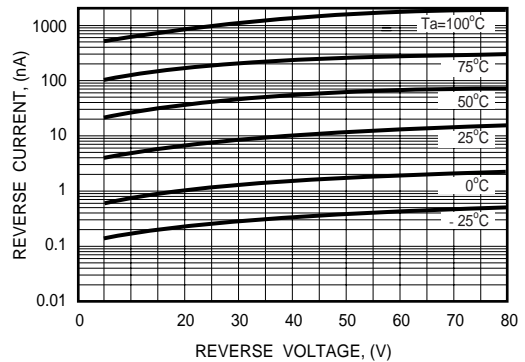

FIG. 5 - REVERSE RECOVERY TIME

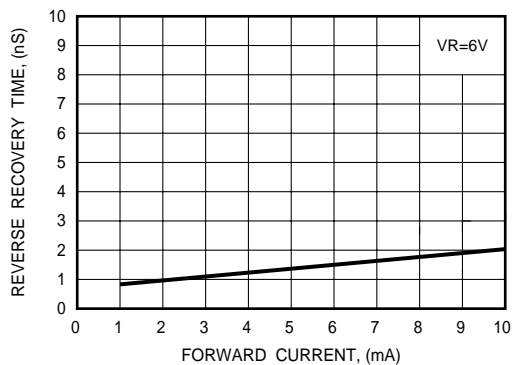

FIG. 6 - REVERSE RECOVERY TIME MEASUREMENT CIRCUIT

